

METER OF NETWORK PARAMETERS
ND20



USER'S MANUAL



Contents

| | |
|---|-----------|
| 1. APPLICATION | 5 |
| 2. METER SET | 6 |
| 3. BASIC REQUIREMENTS AND OPERATIONAL SAFETY | 6 |
| 4. INSTALLATION | 7 |
| 5. METER DESCRIPTION | 8 |
| 6. ND20 PROGRAMMING | 12 |
| 7. UPDATING OF SOFTWARE..... | 35 |
| 8. RS-485 INTERFACE..... | 37 |
| 9. ERROR CODES | 60 |
| 10. TECHNICAL DATA | 62 |
| 11. VERSION CODES | 66 |

1. APPLICATION

The N20D meter is a digital programmable panel meter destined for the measurement of single-phase power network parameters (2-wire network) and 3-phase, 3,4-wire network in balanced and unbalanced systems with the simultaneous display of measured quantities on a LCD display. The meter enables the control and optimization of power electronics devices, systems and industrial installation operations.

The meter ensures the measurement of: rms values of voltage and current, active, reactive and apparent power, active, reactive energy, power factors, frequency, 15, 30, 60 minutes' mean active power, archive of power profile, THD and harmonic measurements. Additionally, the current value in the neutral wire is calculated. Voltages and currents are multiplied by given voltage and current ratios of measuring transformers. Indications of power and energy take into consideration values of programmed ratios. The value of each measured quantity can be transmitted to the master system through the RS-485 interface. The relay output signals the overflow of the chosen quantity, and the pulse output can be used for the consumption check of 3-phase active and reactive energy.

The meter has additionally a continuous current output.

The meter has a galvanic separation between respective blocks:

- supply,
- measuring inputs,
- voltage and current inputs,
- analog output,
- RS-485 output,
- impulse output.

2. METER SET

The set of the ND20 meter is composed of:

1. ND20 meter 1 pc.
2. user's manual 1 pc.
3. seal 1 pc.
4. holders to fix the meter in the panel... 4 pcs

3. BASIC REQUIREMENTS AND OPERATIONAL SAFETY

In the safety service scope, the ND20 meter meets to requirements of the EN 61010 -1 standard.



Observations Concerning the Operational Safety:

- All operations concerning transport, installation, and commissioning as well as maintenance, must be carried out by qualified, skilled personnel, and national regulations for the prevention of accidents must be observed.
- Before switching the meter on, one must check the correctness of connection to the network.
- Before removing the meter housing, one must switch the supply off and disconnect measuring circuits
- The removal of the meter housing during the guarantee contract period may cause its cancellation.
- The ND20 meter is destined to be installed and used in industrial electromagnetic environment conditions.
- One must remember that in the building installation, a switch or a circuit-breaker should be installed. This switch should be located near the device, easy accessible by the operator, and suitably marked.

4. INSTALLATION

The ND20 meter is adapted to be fixed on a panel by means of holders. The fitting way is presented on the fig.1.

Housing overall dimensions: 96 x 96 x 77 mm. At the rear side of the meter, there are screw terminal strips which enable the connection of external wires with a cross-section up to 2.5 mm².

One must prepare a 92.5^{+0.6} x 92.5^{+0.6} mm cut-out in the panel. The material thickness which the panel is made from should not exceed 15 mm. Insert the meter from the frontal panel side with the disconnected supply voltage. After the insertion into the hole, fix the meter by means of holders.

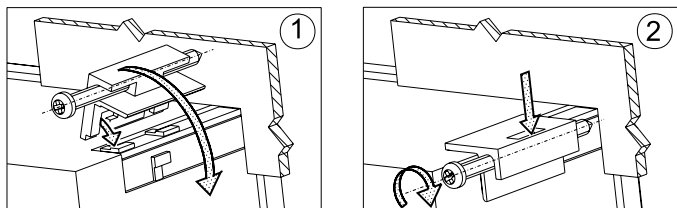

Fig. 1. Meter fitting

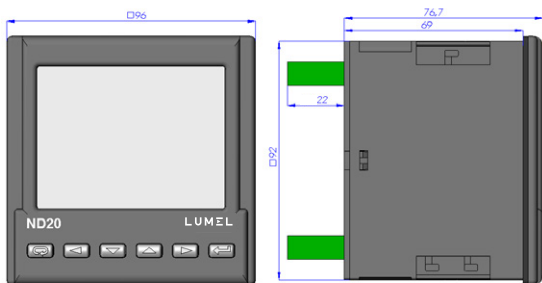

Fig. 2 Meter overall dimensions

5. METER DESCRIPTION

5.1 Current Inputs

All current inputs are galvanically isolated (internal current transformers). The meter is adapted to co-operate with external measuring current transformers. Displayed current values and derivative quantities are automatically recoun in relation to the introduced external current transformer ratio. Current inputs have programmable ranges: 1 A or 5 A.

5.2 Voltage Inputs

Quantities on voltage inputs are automatically converted acc. to the introduced ratio of the external voltage transformer. Voltage inputs have programmable ranges: $3 \times 57.7/100 \text{ V}$, $3 \times 69.3/120 \text{ V}$, $3 \times 230/400 \text{ V}$.

5.3 Connection Diagrams

a)

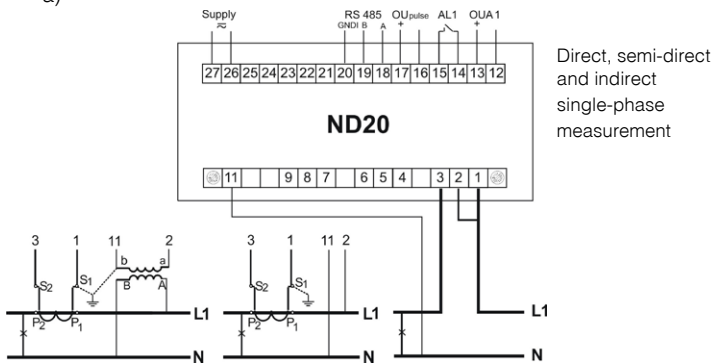

b)

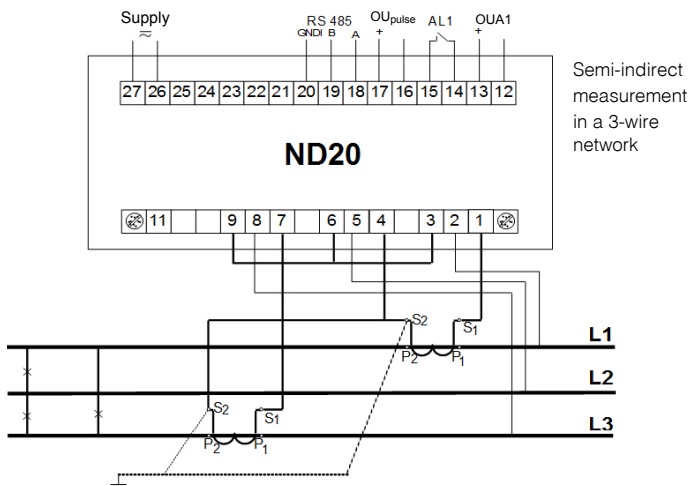
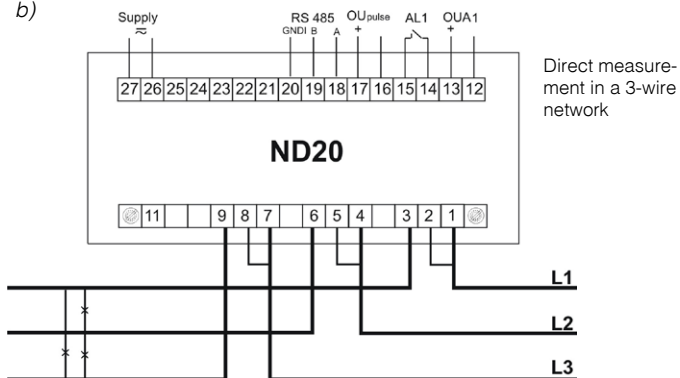

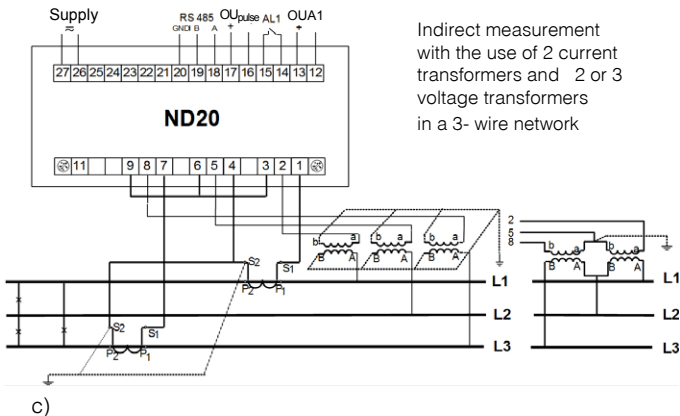

Indirect measurement with the use of 2 current transformers and 2 or 3 voltage transformers in a 3- wire network

Direct measurement in a 4-wire network.

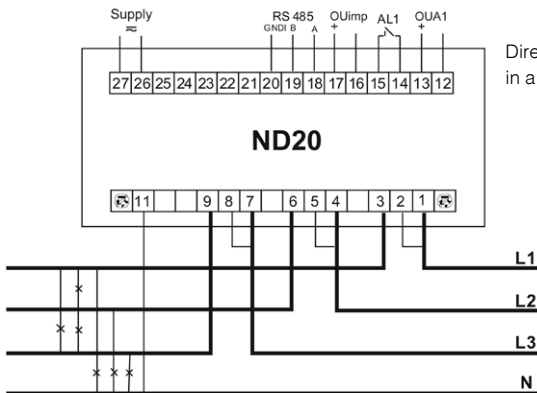

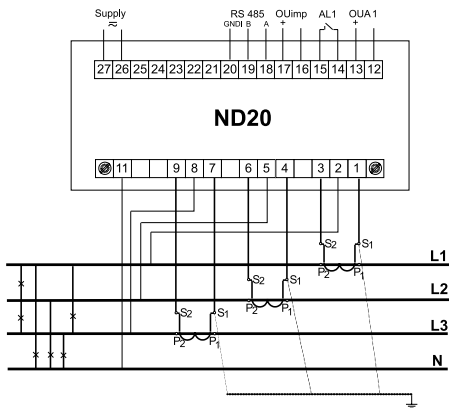

Semi-indirect measurement
in a 4-wire network.

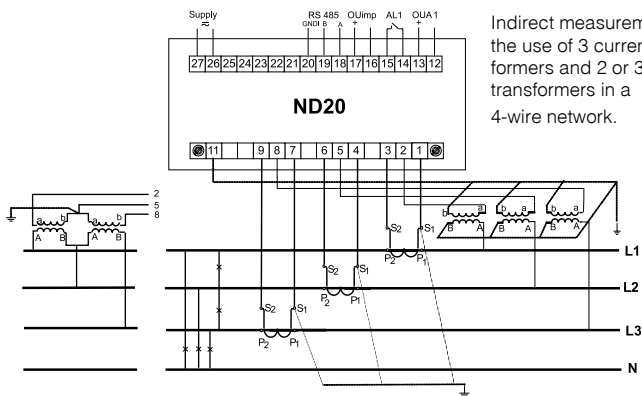

Indirect measurement with
the use of 3 current trans-
formers and 2 or 3 voltage
transformers in a
4-wire network.

Fig 3. Meter connection diagrams in a:
a) single-phase network, b) 3-phase - 3 wire network,
c) 3-phase - 4-wire network

6. ND20 PROGRAMMING

6.1 Frontal Panel

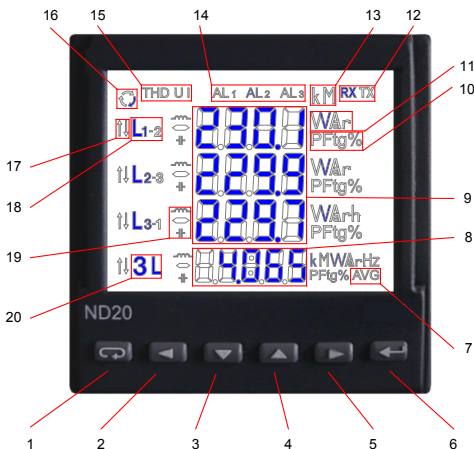

Fig 4. Frontal panel

Description of the frontal panel:

- | | |
|--|--|
| 1 – abandon push-button – ESC | 11 – units of displayed values |
| 2 – push-button to displace to the left | 12 – symbols of digital data transmission |
| 3 – push-button to decrease the value | 13 – multipliers of basic values |
| 4 – push-button to increase the value | 14 – symbols of alarm switching on/occurrence |
| 5 – push-button to displace to the right | 15 – symbols of harmonic value, THD display |
| 6 – acceptance push-button - ENTER | 16 – symbols of energy flow |
| 7 – symbol of displayed value of averaged active power | 17 – symbols of min / max quantities |
| 8 – display field of mean values, frequency, time, power guard | 18 – symbols of quantity affiliation to respective phase |
| 9 – display field of basic quantities, energy, THD, harmonics, date (rows 1, 2, 3) | 19 – symbols of power, energy character |
| 10 – symbols indicating the display of power factor PF, tgφ factor and THD (row 4) | 20 – symbol of 3-phase quantity display |

6.2 Messages after Switching the Supply on

After switching the supply on, the meter performs the display test and display the **nd20** meter name, rated current and voltage, the current program version, and next displays the measured values.

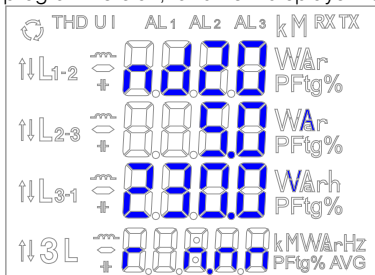





where: n.nn is the number of the current program version or the number of the custom-made version.

Fig. 5. Message after starting the meter

Caution! If on displays the message **Err Cal** or **Err EE** appears, one must contact the service shop.



6.3 Monitoring of Parameters

In the measuring mode, quantities are displayed acc. to settled tables.



The pressure of the  push-button (left) or  push-button (right) causes the transition between displayed quantities. The pressure of the  push-button (Enter) causes the transition between mean and additional displayed values. The pressure of the  push-button (down) causes the monitoring of the minimum value, however the pressure of the  push-button (up) causes the monitoring of the maximum value.

The pressure of the  (ESC) push-button during the monitoring of these values, erases suitably minimum or maximum values. During the operation in the measuring mode of all harmonics (ALL-table 3), instead

of harmonic energy, harmonic percentage values are displayed.

Through  and  push-buttons, one can switch between successive harmonics. The harmonic no is alternately displayed with the value. Through the RS-485 interface one can set up the values, that would be visualized (starting from version 1.02).



The error display is described in the chapter 8.

When displaying the reactive power, a marker indicating the load character is displayed, capacitive () or inductive ()

Displayed quantities in the field 9 (fig. 4.) for 3-phase 4-wire measurement mode 3Ph/4W and single-phase 1Ph/2W are presented in the table 1a and 1b.

Table 1a

| Backlit symbols | | L ₁ , V L ₂ , V L ₃ , V | L ₁₋₂ , V L ₂₋₃ , V L ₃₋₁ , V | L ₁ , A L ₂ , A L ₃ , A | L ₁ , W L ₂ , W L ₃ , W | L ₁ , Var L ₂ , Var L ₃ , Var | L ₁ , VA L ₂ , VA L ₃ , VA | L ₁ , PF L ₂ , PF L ₃ , PF | L ₁ , tg L ₂ , tg L ₃ , tg | kWh |
|------------------|-------|--|--|--|--|--|---|---|---|--|
| Displayed values | row 1 | U ₁ | U ₁₂ ¹ | I ₁ | P ₁ | Q ₁ | S ₁ | PF ₁ | tg ₁ | Imported active energy ₂ EnP |
| | row 2 | U ₂ ¹ | U ₂₃ ¹ | I ₂ ¹ | P ₂ ¹ | Q ₂ ¹ | S ₂ ¹ | PF ₂ ¹ | tg ₂ ¹ | |
| | row 3 | U ₃ ¹ | U ₃₁ ¹ | I ₃ ¹ | P ₃ ¹ | Q ₃ ¹ | S ₃ ¹ | PF ₃ ¹ | tg ₃ ¹ | |
| Displaying | | optional | | | | | | | | |

| Backlit symbols | | -, kWh |  kVarh |  kVarh | L ₁ , U/ THD U L ₂ , U/ THD U L ₃ , U/ THD U | L ₁ , I/ THD I L ₂ , I/ THD I L ₃ , I/ THD I |
|------------------|-------|-------------------------------------|--|--|---|---|
| Displayed values | row 1 | Exported active energy ₂ | reactive inductive energy / reactive positive energy ₂ | reactive capacitive energy / reactive negative energy ₂ | Uh ₁ V / THD1 % | Ih ₁ A / THD1 % |
| | row 2 | | | | Uh ₂ V / THD2 % ¹ | Ih ₂ A / THD2 % ¹ |
| | row 3 | | | | Uh ₃ V / THD3 % ¹ | Ih ₃ A / THD3 % ¹ |
| Displaying | | optional | | | | |

| Backlit symbols | | kWh U I | L ₁ , U L ₂ , U L ₃ , U | -, kWh U I | L ₁ , I L ₂ , I L ₃ , I | c | | W var VA |
|------------------|-------|--|--|--|--|-------------------------|-------|-----------------------|
| Displayed values | row 1 | imported harmonic active energy ¹ | Uh1n* % | exported harmonic active energy ¹ | Uh1n* % | cosinusφ ₁ | year | P _{3phase 1} |
| | row 2 | | Uh2n* % ¹ | | Uh2n* % ¹ | cosinusφ _{2 1} | month | Q _{3phase 1} |
| | row 3 | | Uh3n* % ¹ | | Uh3n* % ¹ | cosinusφ _{3 1} | day | S _{3phase 1} |
| Displaying | | optional | | | | | | |

* Harmonic voltage (current) of L1, L2, L3 phases for n-harmonic

Displayed quantities in the field 8 (fig. 4.)

Table 1b

| Displayed symbols | 3L, A | A | 3L, W | 3L, var | 3L, VA | 3L, PF | 3L, tg | 3L, W _{AVG} |
|-------------------------------|---------------------------------------|-------------------|----------------------------------|----------------------------------|----------------------------------|--|--|---|
| Displayed values in the row 4 | I _{mean 3phase} ¹ | I(N) ¹ | P _{3phase} ¹ | Q _{3phase} ¹ | S _{3phase} ¹ | PF _{mean 3phase} ¹ | tg _{mean 3phase} ¹ | P _{3phase (15, 30 or 60 min)} ² |
| Displaying | optional | | | | | | | |



| Backlit symbols | 3L, c | | Hz | % | 3L, THD U | 3L, THD I |
|-------------------------------|---|----------------|-----------|---|---|---|
| Displayed values in the row 4 | cosinus(φ) _{3phase} ¹ | hour : minutes | frequency | Consumption of ordered power (in 15, 30 or 60 minutes' time) ² | U _{hmean V/ THD U_{mean U}} ¹ | I _{hmean A/ THD I_{mean U}} ¹ |
| Displaying | optional | | | | | |

In 1Ph/2W measurement mode:

- 1 - values are not calculated and not displayed,
- 2 - values calculated as corresponding values of first phase

Displayed quantities in the field 9 (fig. 4.) for 3-phase 3-wire measurement mode 3Ph/3W and single-phase 1Ph/2W are presented in the table 2a and 2b.

Tablica 2a

| | | | | | | | |
|------------------|-------|--|--|------------------------|------------------------|--|--|
| Backlit symbols | | L ₁₋₂ , V L ₂₋₃ , V L ₃₋₁ , V | L ₁ , A L ₂ , A L ₃ , A | kWh | -, kWh |  kvar |  kvar |
| Displayed values | row 1 | U12 | I1 | imported active energy | exported active energy | reactive inductive energy / reactive positive energy | reactive capacitive energy / reactive negative energy |
| | row 2 | U23 | I2 | | | | |
| | row 3 | U31 | I3 | | | | |
| Displaying | | optional | | | | | |

| | | | |
|-------------------|-------|----------|---------------------|
| Displayed symbols | | | W var VA |
| Displayed values | row 1 | year | P _{3phase} |
| | row 2 | month | Q _{3phase} |
| | row 3 | day | S _{3phase} |
| Displaying | | optional | |

Displayed quantities in the field 8 (fig. 4.)

Table 2b

| | | | | | | | |
|-------------------------------|--------------------------|---------------------|---------------------|---------------------|---------------------------|---------------------------|--|
| Displayed symbols | 3L, A | 3L, W | 3L, var | 3L, VA | 3L, PF | 3L, tg | 3L, W _{AVG} |
| Displayed values in the row 4 | I _{mean 3phase} | P _{3phase} | Q _{3phase} | S _{3phase} | PF _{mean 3phase} | t _{gmean 3phase} | P _{3phase (15, 30 or 60 min)} |
| Displaying | optional | | | | | | |

| | | | | |
|-------------------------------|-------------------------------------|----------------|-----------|--|
| Backlit symbols | 3L, c | | Hz | % |
| Displayed values in the row 4 | cosinus(Φ) _{3phase} | hour : minutes | frequency | Consumption of ordered power (in 15, 30 or 60 minutes' time) |
| Displaying | optional | | | |

Performed calculations:

Reactive power (the calculation method configured):

$$Q = \sqrt{S^2 - P^2}$$

$$\text{or } Q = \sum_{i=1}^k U_i * I_i * \sin(\angle U_i, I_i)$$

where k – harmonic number ($k = 21$ dla 50 Hz, $k = 18$ dla 60 Hz)

Power factor PF: $PF = P / S$

Tangens power: $tg\varphi = Q / P$

Cosinus: cosinus between U and I

The exceeding of the upper indication range is signaled on the display by upper horizontal lines, however the exceeding of the lower range is signaled by lower horizontal lines.

In case of averaged power measurement $P_{3\text{-phase}}$, single measurements are carried out with a 15 seconds' quantum. Suitably to the 15 min, 30 min, 60 min selection, 60, 120 or 240 measurements are averaged. After starting the meter or the power erasing, the first value will be calculated after 15 seconds since the meter switching on or erasing. Till the time to obtain all active power samples, the value of averaged power is calculated from already measured samples.

The current in the neutral wire $I_{(N)}$ is calculated from phase current vectors

The value of consumed ordered power can be used for a previous warning against the exceeding of ordered power and to escape of fines related with it. The consumption of ordered power is calculated on the base of time interval set for the synchronization of the mean active power and the value of ordered power (section 6.5.1). The consumption example is presented in the section 6.5.3.

The alarm switching on is signaled by the lighting of the AL1 inscription (in the mode A3non, A3nof, A3_on, A3_of: of AL1, AL2, AL3 inscriptions). The end of alarm duration at the alarm signaling support switched on, is indicated by the pulsation of the AL1 inscription (in the mode A3non, A3nof, A3_on, A3_of: of AL1, AL2, AL3 inscriptions).

6.4 Operating modes

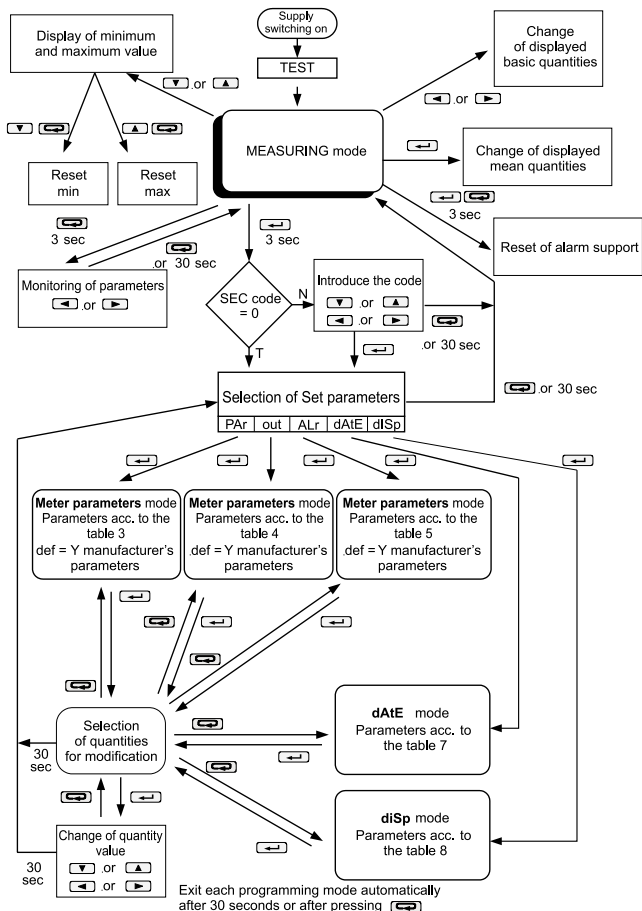

Fig. 6. Operating modes of the ND20 meter.

6.5. Parameter Settings

For the configuration of ND20 meters, the free eCon software is available at www.lumel.com.pl.

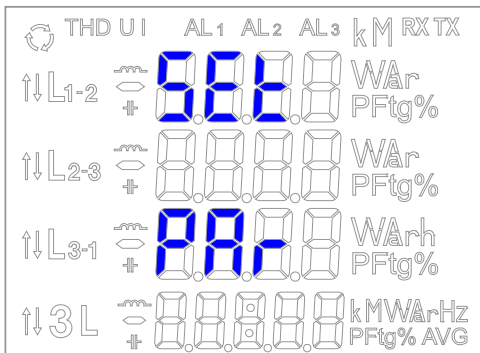



Fig 7. Setup menu

The entry in the programming mode is carried out through the pressure and holding down of the  push-button during ca 3 sec. The entry in the programming mode is protected by the access code. If there is not such a code, the program transits into the programming option. The inscription SET is displayed (in the first row) and the first group of PAR parameters. The monitoring of parameters is always available through the pressure and holding down the  push-button during ca 3 sec.

| | | | | | | | | | | | | | | |
|----------------------------------|---|--|--|---|--|---|--|---|---|---|---|--|--|---|
| PR Meter parameters | SEC Access code | rn.i Current range | rn.U Voltage range | cr.i Current ratio | cr.U Voltage ratio | SYN Synchronizing of the active mean power | nPR Number of the measuring electronic / THD | ErLi Storage of the minimum value with errors | q.t Way to count reactive power | En.q Way to count reactive energy | LCHt Display backlight | En.Q Erasing of watt-hour meters | PR.Q Erasing of active mean power | |
| OUT Output parameters | PR.Q Erasing of the active mean power archive | PROR Ordered power | CONN System connection | dEF Manufacturer's parameters | Rn.U Lower value of the input range | Rn.OH Higher value of the output range | Rn.R Mode of output work | Rn.ER Output when error | Io.n Quantity of impulses | Addr Address MOBBUS network | Tr.Yb Transmission mode | bRUD Rate | dEF Manufacturer's parameters | |
| AL Alarm parameters | RL.n Quantity on the continuous output (table 6 in the user's manual) | Rn.t Type of continuous output as output | Rn.iL Lower value of the input range | Rn.iH Higher value of the input range | RL.dT Time delay of the switching retraction | RL.S Support of the alarm advance signaling | RL.b Mode of alarm re-switching | dEF Manufacturer's parameters | | | | | | |
| dRT.E Date and time | t.H Hour, minute | t.d Month, day | t.y Year | RL.oF Lower value of the input range | | | | | | | | | | |
| dI.SP Displayed values | U.Ln LN voltages | U.LL LL Voltages | i.Ln Phase currents | P Phase active powers | Q Phase reactive powers | S Phase apparent powers | PF Power factors PF | tL Power phase Trans light | En.P Incremented active energy | En.P- Erased active energy | En.Q Phase inductive energy | En.Q- Reactive capacitive energy | tHdi THD of phase currents | |
| | En.H Incremented harmonic energy | En.H- Decrement harmonic energy | Co.S Cosinus | dRT.E Date | P95 P95 phase, S3phase, S3phase | i.R Three-phase current | i.n Current in neutral wire | 3P Power S3-phase | 3Q Power Q3phase | 3S Power S3phase | PF.R Three-phase mean Power Factor PF | tL.R Three-phase Tangent | PR.Ud Power P3phase (15,30 or 60 mmes) | Co.S Three-phase mean Cosinus |
| | HoUr Hour | FrEq Frequency | P.or Three ordered power | tH3U THD of phase voltages | tH3I THD of phase currents | on Display of phase-ON | off Display of phase-OFF | | | | | | | |

Fig 8. Programming matrix.

6.5.1 Setting of Meter Parameters

Select the **PAR** mode in options (by  or  push-buttons) and approve the choice by the  push-button.

Table 3







| Item | Parameter name | Designation | Range | Notes/description | Manufacturer's value |
|------|---|-------------|----------------------------|---|----------------------|
| 1 | Introduction of the access code | SEc | oFF, 0...60000 | 0 - without code | 0 |
| 2 | Current range | rn_I | 1A, 5A | 1A - current range 1A 5A - current range 5A | 5A * |
| 3 | Voltage range | rn_U | 57.7V, 69.3V, 230V | 57.7V – voltage range 57.7V 69.3V – voltage range 69.3V 230V – voltage range 230V | 230V * |
| 4 | Ratio of the current transformer | tr_I | 1 ... 10000 | | 1 |
| 5 | Ratio of the voltage transformer | tr_U | 0.1 ... 4600.0 | | 1 |
| 6 | Synchronization of mean active power | Syn | 15, c_15, c_30, c_60 | Synchronization of mean active power: 15 - 15 minutes' walking window (record synchronized with the clock every 15 minutes) c_15 – measurement synchronize with the clock every 15 minutes. c_30 – measurement synchronized with the clock every 30 minutes, c_60 – measurement synchronized with the clock every 60 minutes, | 15 |
| 7 | Number of the measured harmonic/ THD | nHAr | tHd, ALL, 2 ... 21 | tHd – THD ALL – successive calculations of harmonics inserted in registers 2...21 – harmonic number (in this mode, the active energy is calculated) | tHd |
| 8 | Storage of minimum and maximum values with errors | erLI | oFF, on | oFF – storage of only correct values (from the measuring range). on – storage of also error occurrences in measurements (values in registers 1e20 and 1e20) | on |

| | | | | | |
|----|------------------------------------|------|---------------------------------|---|-------|
| 9 | Way to calculate reactive power | q_t | trGLE, SInUS | $\text{TrGLE: } Q = \sqrt{S^2 - P^2}$ $\text{SInUS: } Q = \sum_{i=1}^k U_i * I_i * \sin(\angle U_i, I_i)$ k - harmonic number, k = 21 for 50 Hz, k = 18 for 60 Hz | trGLE |
| 10 | Way to calculate reactive energy | En_q | cAP, SIGn | cAP – inductive and capacitive energy SIGn – positive and negative energy | cAP |
| 11 | Display backlit | LGht | oFF, 1..60, on | off – disabled, on – enabled, 1..60 – time in seconds of backlit support since the push-button pressure. | on |
| 12 | Erasing of watt-hour meters | En 0 | no, EnP, Enq, EnH, ALL | no – lack of actions, EnP – erasing of active energy, Enq – erasing of reactive energy, EnH – erasing of harmonic energy. ALL – erasing of all energy | no |
| 13 | Erasing of mean active power | PA 0 | no, yES | yES -erasing of power | no |
| 14 | Reset of mean active power archive | PAr0 | no, yES | yES - erasing of archive | no |
| 15 | Ordered power | PAor | 0...144.0 | Ordered power for forecasting the power consumption in % of the rated value | 100.0 |
| 16 | Measurement mode | conn | 3Ph-4, 3Ph-3, 1Ph-2 | Meter connection way | 3Ph-4 |
| 17 | Manufacturer's parameters | dEf | no, yES | Restoration of manufacturer's parameters of the group. | no |

* - rated value for the calculated quantities in% of the rated value.

The automatic erasing of energy is carried out:

- for active energy when changing: voltage or current ratio;
- for reactive energy when changing: voltage or current ratio, the way of reactive power calculation;
- for energy of harmonics when changing: voltage or current ratio, when changing the measured harmonic number.

Values are set by means of  and  push-buttons, however the position of the set digit is selected by means of  and  push-buttons. The active position is signaled by the cursor. The value is accepted by  the push-button and resigned by the pressure of the  push-button. During the acceptance, the value insertion possibility in the range is checked. In case when the value is set beyond the range, the meter remains in the parameter edition mode, however the value is set on the maximum value (when the value is too higher) or on the minimum value (when the value is too lower).

6.5.2. Setting of Output Parameters

Select the **out** mode in options and approve the choice by the  push-button.

Table 4

| Item | Parameter name | Designation | Range | Notes/description | Manufacturer's value |
|------|--|-------------|---------------------|---|----------------------|
| 1 | Quantity on the continuous output (code acc. to the table 6) | An_n | table 6 | (the code acc. to the table 6) | P |
| 2 | Type of continuous output | An_t | 0_20, 4_20 | The selection 4_20 causes the switching on of the minimum output current limitation on the level ca 3.8 mA. | 0_20 |
| 3 | Lower value of the input range | AnL | -144.0 ... 144.0 | in % of the rated quantity value | 0 |
| 4 | Upper value of the input range | AnH | -144.0 ... 144.0 | in % of the rated quantity value | 100.0 |
| 5 | Lower value of the output range | AnOL | 0.00 ... 24.00 | in mA | 0 |
| 6 | Upper value of the output range | AnOH | 0.00 ... 24.00 | in mA | 20 |

| | | | | | |
|----|---------------------------|------|------------------------------|--|-------|
| 7 | Output operation mode | Antr | nor, AnOL, AnOH | Operating mode of the continuous output: nor – normal work, AnOL – set value AnOL, AnOH – set value AnOH, | nor |
| 8 | Output value at error | AnEr | 0 ... 24 | in mA | 24 |
| 9 | Number of impulses | Io_n | 1000...20000 | Number of impulses for 1 kWh | 5000 |
| 10 | Address in MODBUS network | Addr | 1 ... 247 | | 1 |
| 11 | Transmission mode | trYb | r8n2, r8E1, r8o1, r8n1 | | 8n2 |
| 12 | Baud rate | bAUd | 4.8 k, 9,6 k, 19.2 k, 38.4 k | | 9,6 k |
| 13 | Manufacturer's parameters | dEf | no, yES | Restoration of manufacturer's parameters of the group | no |

6.5.3. Setting of Alarm Parameters



Select the **ALr** mode in options and approve the choice by the  push-button.

Table 5

| Item | Parameter name | Designation | Range | Notes/description | Manufacturer's value |
|------|---|-------------|---|-------------------|----------------------|
| 1 | Quantity in the alarm output (code acc. to the table 6) | AL_n | table 6 | | P |
| 2 | Alarm type | AL_t | n-on, n-oFF, on, oFF, H-on, H-oFF, A3non, A3nof, A3_on, A3_of | Fig. 9 | n-on |

| | | | | | |
|---|--|------|------------------|---|-----|
| 3 | Lower value of the input range | ALoF | -144.0 ... 144.0 | in % of the rated quantity value | 99 |
| 4 | Upper value of the input range | ALon | -144.0 ... 144.0 | in % of the rated quantity value | 101 |
| 5 | Time delay of the switching reaction | ALdt | 0 ... 900 | in seconds (for quantities AL_n =P_ord the delay occurs only when switching the alarm on) | 0 |
| 6 | Support of the alarm occurrence signaling | AL_S | oFF, on | In the situation when the support function is enabled, after the retreat of the alarm state the alarm symbol is not blanked but begins to pulsate. The signaling exists till the moment of blanking it by means of the  and  push-buttons combination (during 3 seconds). The function concerns only and exclusively the alarm signaling, then relay contacts will be active without support, acc. to the selected type of alarm. | oFF |
| 7 | Interlocking of a renewed alarm switching on | AL_b | 0...900 | in seconds | 0 |
| 8 | Manufacturer's parameters | dEF | no, yES | Restoration of manufacturer's parameters of the group. | no |

The write of the value ALon lower than ALoF switches the alarm off.

Selection of the monitored value:

Table 6

| Item/ value in re- gister 4015 | Di- play- ed para- meter | Kind of quantity | Value for the percentage conversion of alarm valu- es and outputs (100%) |
|--|--------------------------------------|---|--|
| 00 | off | lack of quantity /alarm disabled/ | none |
| 01 | U_1 | voltage of phase L1 | $U_n [V]^*$ |
| 02 | I_1 | current in the phase wire L1 | $I_n [A]^*$ |
| 03 | P_1 | active power of phase L1 | $U_n \times I_n \times \cos(0^\circ) [W]^*$ |
| 04 | q_1 | reactive power of phase L1 | $U_n \times I_n \times \sin(90^\circ) [\text{var}]^*$ |
| 05 | S_1 | apparent power of phase L1 | $U_n \times I_n [\text{VA}]^*$ |
| 06 | PF1 | active power factor PF of phase L1 | 1 |
| 07 | tg1 | $\text{tg}\phi$ coefficient of phase L1 | 1 |
| 08 | U_2 | voltage of phase L2 | $U_n [V]^*$ |
| 09 | I_2 | current in the phase wire L2 | $I_n [A]^*$ |
| 10 | P_2 | active power of phase L2 | $U_n \times I_n \times \cos(0^\circ) [W]^*$ |
| 11 | q_2 | reactive power of phase L2 | $U_n \times I_n \times \sin(90^\circ) [\text{var}]^*$ |
| 12 | S_2 | apparent power of phase L2 | $U_n \times I_n [\text{VA}]^*$ |
| 13 | PF2 | active power factor PF of phase L2 | 1 |
| 14 | tg2 | $\text{tg}\phi$ coefficient of phase L2 | 1 |
| 15 | U_3 | voltage of phase L3 | $U_n [V]^*$ |
| 16 | I_3 | current in the phase wire L3 | $I_n [A]^*$ |
| 17 | P_3 | active power of phase L3 | $U_n \times I_n \times \cos(0^\circ) [W]^*$ |
| 18 | q_3 | reactive power of phase L3 | $U_n \times I_n \times \sin(90^\circ) [\text{var}]^*$ |
| 19 | S_3 | apparent power of phase L3 | $U_n \times I_n [\text{VA}]^*$ |
| 20 | PF3 | active power factor PF of phase L3 | 1 |

| | | | |
|----|-------|--|--|
| 21 | tg3 | $\text{tg}\phi$ coefficient of phase L3 | 1 |
| 22 | U_A | mean 3-phase voltage | U_n [V] * |
| 23 | I_A | mean 3-phase current | I_n [A] * |
| 24 | P | 3-phase active power (P1 + P2+ P3) | $3 \times U_n \times I_n \times \cos(0^\circ)$ [W] * |
| 25 | q | 3-phase reactive Power (Q1 + Q2 + Q3) | $3 \times U_n \times I_n \times \sin(90^\circ)$ [var] * |
| 26 | S | 3-phase apparent Power (S1 + S2 + S3) | $3 \times U_n \times I_n$ [VA] * |
| 27 | PF_A | 3-phase active power factor PF | 1 |
| 28 | Tg_A | 3-phase $\text{tg}\phi$ coefficient | 1 |
| 29 | FrEq | frequency | 100 [Hz] |
| 30 | U12 | phase-to-phase voltage L1-L2 | $\sqrt{3} U_n$ [V] * |
| 31 | U23 | phase-to-phase voltage L2-L3 | $\sqrt{3} U_n$ [V] * |
| 32 | U31 | phase-to-phase voltage L3-L1 | $\sqrt{3} U_n$ [V] * |
| 33 | U4_A | mean phase-to-phase voltage | $\sqrt{3} U_n$ [V] * |
| 34 | P_At | mean active power | $3 \times U_n \times I_n \times \cos(0^\circ)$ [W] * |
| 35 | P_ord | Used percentage of the ordered active power (consumed energy) | 100% |

* U_n, I_n – rated values of voltages and currents

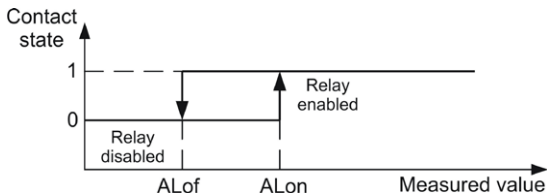

a) n-on

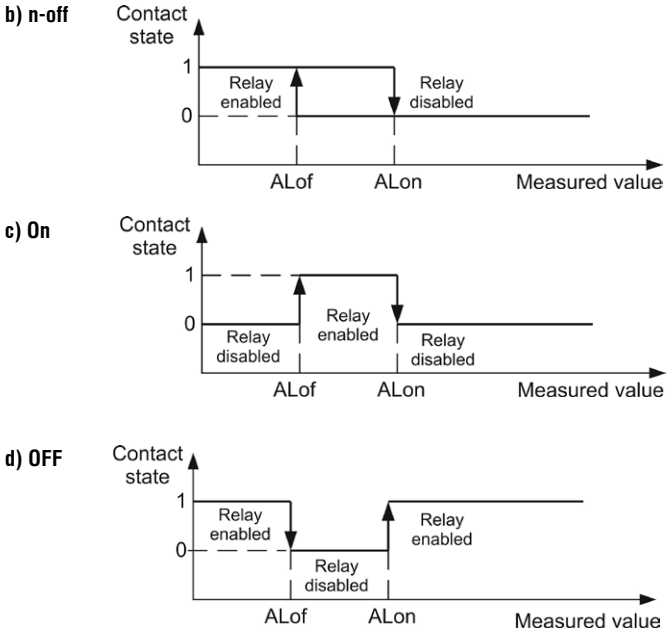



Fig. 9. Alarm types: a),b) normal c) enabled d) disabled

Remaining types of the alarm:

- H-on – always enabled;
- H-off – always disabled,
- A3non – when the “n-on” alarm type occurs on any of the phases – the relay switches on and the corresponding symbol is illuminated (AL1 – phase 1, AL2 – phase 2, AL3 – phase 3). When all alarms fade away, the relay switches off.
- A3nof – when the “n-off” alarm type occurs on any of the phases – the relay switches on and the corresponding symbol is illuminated (AL1 – phase 1, AL2 – phase 2, AL3 – phase 3). When all alarms fade away, the relay switches off.

- A3_on – when the “on” alarm type occurs on any of the phases – the relay switches on and the corresponding symbol is illuminated (AL1 – phase 1, AL2 – phase 2, AL3 – phase 3). When all alarms fade away, the relay switches off.
- A3_of – when the “off” alarm type occurs on any of the phases – the relay switches on and the corresponding symbol is illuminated (AL1 – phase 1, AL2 – phase 2, AL3 – phase 3). When all alarms fade away, the relay switches off

In the “A3” alarm series, the alarm value must range from 0-7. They work with equal ALof and ALon hysteresis thresholds for all of the phases. Signaling sustainment can be switched off by pressing together  and  buttons (for 3 seconds).

Example no 1 of alarm setting:

Set the alarm of n-on type for the monitored quantity P – 3-phase active power, Ranges set 5 A; 230V. Switching the alarm on, after exceeding 3800 W, switching the alarm off after decreasing 3100 W.

Calculate: rated 3-phase active power: $P = 3 \times 230 \text{ V} \times 5 \text{ A} = 3450 \text{ W}$
 $3450 \text{ W} - 100 \%$ $3450 \text{ W} - 100 \%$

$3800 \text{ W} - \text{ALon} \%$ $3100 \text{ W} - \text{ALoF} \%$

It appears: $\text{ALon} = 110 \%$ $\text{ALoF} = 90 \%$

Set: Monitored quantity: P; Kind of alarm: n-on, ALon 110, ALoF 90.0.

Example no 2 of alarm setting:

Set the alarm of earliest warning about the possibility to exceed the ordered 1 MW power on the level 90% at the one hour accounting. Measuring current transformer 2500/5 A, voltage :230 V, Instantaneous maximum import of power: 1.5 MW.

Calculate: rated 3-phase active power of the ND20 meter: $P = 3 \times 230 \text{ V} \times 2500 \text{ A} (500 * 5 \text{ A}) = 1.725 \text{ MW} (500 * 3450 \text{ W}) - 100\%$;

90% of ordered power / rated power = $90.0\% * 1 \text{ MW} / 1.725 \text{ MW} = 52.1 \%$ of the rated meter value (rounding down).

The' ordered hourly power (energy for consumption): $1 \text{ MWh} / 4 \text{ quarters} = 900 \text{ MWs}$,

90% - 810 MWs . Remaining 10% at maximum power import would be used in time: $900 \text{ MWs} / 1.5 \text{ MW} = 60 \text{ s}$

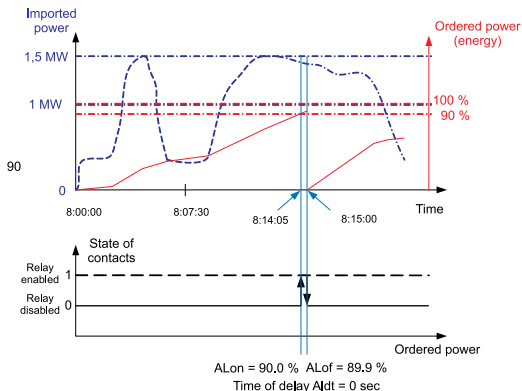

Fig 10. Measurement of 60 minutes' active power consumption synchronized with the clock, with alarm set on a 90% consumption.

An example of the parameter value utilization of ordered active power to switch the alarm on is presented on the fig. 10.

The time delay is set on 0 sec.

In the calculated example, for remaining 10% of ordered power, at the maximum power consumption, devices could still work during 60 sec without exposing customers to fines. when setting the time delay ALdt on 60 sec, the alarm would not be enabled.

Set: Monitored quantity: P_ord, Kind of alarm: n-on, ALon = 90.0, ALof = 89.9, Tr_1 = 500, Syn = c_60, Time delay ALdt = 0 or 240 s.

In the case of setting Syn = 15 (15-minute walking window), the used ordered active power is a average value based on the average 15 minutes active power ratio (walking window) to the ordered power.

6.5.4 Setting Date and Time

Select the **dAtE** mode in options and approve the choice by the  push-button. Seconds are reset after setting hour and minute values.

Table 7

| Item | Parameter name | Designation | range | Manufacturer's value |
|------|----------------|-------------|--------------------|----------------------|
| 1 | Hour, minute | t_H | 0 ... 23, 0 ... 59 | 0.00 |
| 2 | Month, day | t_d | 1 ... 12, 1 ... 31 | 1.01 |
| 3 | Year | t_y | 2001 ... 2100 | 2001 |

6.5.5. Setting of displayed values

Select the **DISP** mode in options and approve the choice by the  push-button.

Table 7

| No. | Parameter name | Designation | Range | Manufacturer's value |
|---------------------------------------|----------------------------------|-------------|---------|----------------------|
| Displayed parameters in the row 1 - 3 | | | | |
| 1 | Phase voltages | U_Ln | oFF, on | on |
| 2 | Phase-to-phase voltages | U_LL | oFF, on | on |
| 3 | Phase currents | I_Ln | oFF, on | on |
| 4 | Active phase powers | P | oFF, on | on |
| 5 | Reactive phase powers | q | oFF, on | on |
| 6 | Apparent phase powers | S | oFF, on | on |
| 7 | Phase PF power factors | PF | oFF, on | on |
| 8 | Phase Tangents φ factors | tG | oFF, on | on |
| 9 | Input active energy | EnP | oFF, on | on |
| 10 | Output active energy | EnP- | oFF, on | on |
| 11 | Inductive reactive energy | Enq | oFF, on | on |
| 12 | Capacity reactive energy | Enq- | oFF, on | on |
| 13 | THD of phase voltage | tHdu | oFF, on | on |
| 14 | THD of phase current | tHdl | oFF, on | on |
| 15 | Harmonic input active energy | EnH | oFF, on | on |
| 16 | Harmonic output active energy | EnH- | oFF, on | on |
| 17 | Phase Cosinus φ | cos | oFF, on | on |
| 18 | Date | date | oFF, on | on |

| | | | | |
|-----------------------------------|---|------|---------|----|
| 19 | 3-phase active, reactive, apparent power | PqS | oFF, on | on |
| Displayed parameters in the row 4 | | | | |
| 20 | Three-phase mean current | I_A | oFF, on | on |
| 21 | Current in neutral wire | I_n | oFF, on | on |
| 22 | Three-phase active power | 3P | oFF, on | on |
| 23 | Three-phase reactive power | 3q | oFF, on | on |
| 24 | Three-phase apparent power | 3S | oFF, on | on |
| 25 | Three-phase mean power factor PF | PF_A | oFF, on | on |
| 26 | Three-phase mean Tangent φ factor | tG_A | oFF, on | on |
| 27 | Three-phase mean active power (15,30 or 60 minutes) | PAvG | oFF, on | on |
| 28 | Three-phase mean Cosinus φ | coSA | oFF, on | on |
| 29 | Hour | HoUr | oFF, on | on |
| 30 | Frequency | Freq | oFF, on | on |
| 31 | Three-phase ordered power | p_or | oFF, on | on |
| 32 | Mean THD of phase voltages | tH3U | oFF, on | on |
| 33 | Mean THD of phase currents | tH3I | oFF, on | on |
| | | | | |
| 34 | Display of parameters - ON | on | no, YES | no |
| 35 | Display of parameters - OFF | off | no, YES | no |

Note! When you turn off the display of all parameters, the phase current values and three-phase mean current are displayed.

6.6. Configuration of THD Measurement, Harmonics and Energy for the Harmonic

The meter has 3 work modes related to the THD and harmonic calculation. When setting the parameter of the harmonic number:

- tHd – the meter measures every 1 second only the THD value for currents and voltages, the result is exposed on the display and expressed in registers in percentages. Energy of harmonics is reset and particular harmonics include the error value (1e20);

- All – the meter measures harmonics from 2 up to 21, for 50 Hz frequency (from 2 up to 18 for 60 Hz frequency). Energy of harmonics is reset.

- 2 – 21 – measurement of the selected harmonic value, every 1 second, the result is exposed on the display and in basic units (V, A) in registers. Energy for the given harmonic is counted up.

The switching of the harmonic number or the change of voltage or current ratio resets energy for harmonics.

6.7. Archive – Active Power Profile

The ND20 meter is equipped with an archive allowing to store up to 9000 measurements of mean active power. Mean active power PAV is archived with a 15, 30, 60 minutes' interval of time, synchronized with the real time clock. In case of operation in the 15 minutes' walking window mode, the archiving is performed in the same way as for the 15 minutes' interval of time (fig. 11). The direct access to the archive is for 15 records including the date, time and value placed in the range of addresses 1000 -1077. The position of the first (oldest) archived sample is placed in the register 1000, however the position of the last archived sample (youngest) is placed in the register 1001. the value of the first record, from 15 available records placed in registers 1003 – 1077, is written in the register 1002. The write of the first read out record value (1 – 9000) causes the data updating of 15 records for readout.

In registers, in which samples were not already been written, are 1e20 values.

The archive is organized in the shape of a circular buffer. After writing the 9000 th value, the next overwrites the oldest with number 0, and the successive, the next with number 1, etc.

If the value of the register 1000 is higher than 1001, that means that the buffer was overflowed one time at least. Eg, the value 15 in the register 1000, and 14 in the register 1001 means, that there were already more than nine thousand samples and oldest samples are from the record 15 up to 9000, next from the record 1 to the youngest record with number 14.

The change of the current or voltage ratio, kind of mean power, causes the archive erasing.

The reset of averaged power or the change of averaging time does not erase the archive.

The automatic erasing of the archive and averaged power is performed when changing the voltage or current ratio.

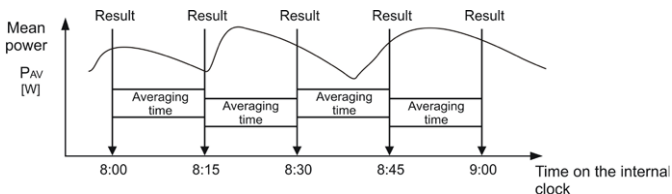

Fig. 11. Measurement of 15 minutes' mean active power synchronized with the clock.

7. UPDATING OF SOFTWARE

Function enabling updating of software from the computer of the PC with software eCon was implementation in meter ND20. Free software eCon and update files are accessible on the site www.lumel.com.pl. The connected to the computer converter RS485 is required on USB to the updating, e.g.: the converter PD10.

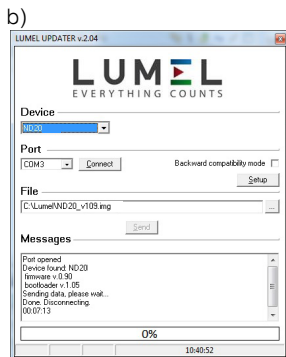
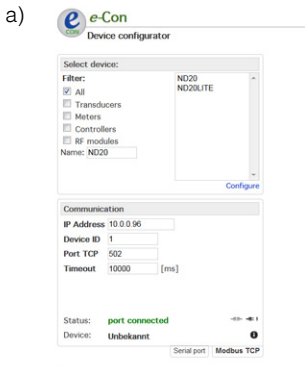





Fig. 13. Program view: a) eCon, b) updating of software

Note! After updating the software, the manufacturer's settings of the meter should be set, so it is recommended to save the meter parameters before updating using the software eCon.

After starting eCon's software COM port, baudrate, transmission mode and address should be set. It can be done in *Options*. Then, ND20 meter should be selected from *Device*. Push icon *Load* to read and save current settings. Open window *Lumel Updater (LU)* – figure 13b from *Updating->Updating of devices firmware*. Push *Connect*. Update progress is shown in *Messages* section. Text *Port opened* appear after correctly opened port. Putting meter in update's mode can be done in two ways: remote from LU (with settings from eCon – port, baudrate, transmission mode and address) or by turning power on while  button pressed (by settings – baudrate 9600, RTU8N2, address 1). Meter display shows the „boot“ inscription with bootloader version, LU shows message „*Device found*“ with name and current version of firmware. Using button  browse to the meter upgrade file. If the file is opened correctly, a *File opened* message is displayed. Press the *Send* button. When upgrade is successfully completed, meter reverts to the default settings and begins normal operation while the information window displays *Done* message and upgrade elapsed time. If the update is unsuccessful, the next update can be made only by switching on the meter's power with the button pressed . Close LU and go to *Restoration of default parameters*. Select checkbox and press *Apply* button. After the LU window is closed, press the *Save* icon to save all initially read parameters. Current firmware version can be checked when meter is power on.

Warning! Turning the meter off during upgrade process may result in permanent damage!

8. RS-485 INTERFACE

The implemented protocol is compliant with the PI-MBUS-300 Rev G, Modicon. Parameter set of the serial ND20 meter link:

- identifier 0xBC
- meter address: 1..247
- baud rate 4.8, 9.6, 19.2, 38.4 kbit/s,
- working mode Modbus RTU,
- information unit 8N2, 8E1, 8O1, 8N1,
- maximum response time 600 ms.
- maximum quantity of read out registers in one request
 - 41 registers – 4 byte registers,
 - 82 registers – 2 byte registers,
- implemented functions 03, 04, 06, 16, 17,
 - 03, 04 - readout of registers,
 - 06 - write of one register,
 - 16 - write of n-registers,
 - 17 - device identification,

Manufacturer's settings: address 1, baud rate: 9600 baud, RTU 8N2 mode,

Readout of n-registers (code 03h)

Example 1 . Readout of 2 registers 16-bit of integer type, starting with the register with the 0FA0h (4000) address - register values 10, 100.

Request:

| Device address | Function | Register address | | Number of registers | | CRC Control sum |
|----------------|----------|------------------|----|---------------------|----|-----------------|
| | | B1 | B0 | B1 | B0 | |
| 01 | 03 | 0F | A0 | 00 | 02 | C7 3D |

Response:

| Device address | Function | Number of bytes | Register address 0FA0 (4000) | | Number of registers 0FA1 (4001) | | CRC Control sum |
|----------------|----------|-----------------|------------------------------|----|---------------------------------|----|-----------------|
| | | | B1 | B0 | B1 | B0 | |
| 01 | 03 | 04 | 00 | 0A | 00 | 64 | E4 6F |

Example 2 . Readout of 2 registers 32-bit of float type as 2 registers 16-bits, starting with the register with the 1B58h (7000) address - register values 10, 100.

Request:

| Device address | Function | Register address | | Number of registers | | CRC Control sum |
|----------------|----------|------------------|----|---------------------|----|-----------------|
| | | B1 | B0 | B1 | B0 | |
| 01 | 03 | 1B | 58 | 00 | 04 | C3 3E |

Response:

| Device address | Function | Number of bytes | Value from register 1B58 (7000) | | Value from register 1B59 (7001) | | Value from register 1B5A (7002) | | Value from register 1B5B (7003) | | CRC Control sum |
|----------------|----------|-----------------|---------------------------------|----|---------------------------------|----|---------------------------------|----|---------------------------------|----|-----------------|
| | | | B3 | B2 | B1 | B0 | B3 | B2 | B1 | B0 | |
| 01 | 03 | 08 | 41 | 20 | 00 | 00 | 42 | C8 | 00 | 00 | E4 6F |

Example 3 . Readout of 2 registers 32-bit of float type as 2 registers 16-bit, starting with the register with the 1770h (6000) address - register values 10, 100.

Request

| Device address | Function | Register address | | Number of registers | | CRC Control sum |
|----------------|----------|------------------|----|---------------------|----|-----------------|
| | | B1 | B0 | B1 | B0 | |
| 01 | 03 | 17 | 70 | 00 | 04 | 4066 |

Response:

| Device address | Function | Number of bytes | Value from register 1770h (6000) | | Value from register 1770h (6000) | | Value from register 1772h (6002) | | Value from register 1772h (6002) | | CRC Control sum |
|----------------|----------|-----------------|----------------------------------|----|----------------------------------|----|----------------------------------|----|----------------------------------|----|-----------------|
| | | | B1 | B0 | B3 | B2 | B1 | B0 | B3 | B2 | |
| 01 | 03 | 08 | 00 | 00 | 41 | 20 | 00 | 00 | 42 | C8 | E4 6F |

Example 4 . Readout of 2 registers 32-bit of float type, starting with the register with the 1D4Ch (7500) address - register values 10, 100.

Request:

| Device address | Function | Register address | | Number of registers | | CRC Control sum |
|----------------|----------|------------------|----|---------------------|----|-----------------|
| | | B1 | B0 | B1 | B0 | |
| 01 | 03 | 1D | 4C | 00 | 02 | 03 B0 |

Response:

| Device address | Function | Number of bytes | Value from register 1D4C (7500) | | | | Value from register 1D4D (7501) | | | | CRC Control sum |
|----------------|----------|-----------------|---------------------------------|----|----|----|---------------------------------|----|----|----|-----------------|
| | | | B3 | B2 | B1 | B0 | B3 | B2 | B1 | B0 | |
| 01 | 03 | 08 | 41 | 20 | 00 | 00 | 42 | C8 | 00 | 00 | E4 6F |

Recording a single register (code 06h)

Example 5 . Recording the value 543 (0x021F) in the register 4000 (0x0FA0)

Request:

| Device address | Function | Register address | | Number of registers | | CRC Control sum |
|----------------|----------|------------------|----|---------------------|----|-----------------|
| | | B1 | B0 | B1 | B0 | |
| 01 | 06 | 0F | A0 | 02 | 1F | CA 54 |

Response:

| Device address | Function | Register address | | Number of registers | | CRC Control sum |
|----------------|----------|------------------|----|---------------------|----|-----------------|
| | | B1 | B0 | B1 | B0 | |
| 01 | 06 | 0F | A0 | 02 | 1F | CA 54 |

Recording to n-registers (code 10h)

Example 6 . Recording 2 registers starting with the register with the 0FA3h (4003) address recorded values 20, 2000.

Request:

| Device address | Function | Register addr. Hi | Register addr. Lo | Register addr. Hi | Register addr. Lo | Number of bytes | Value for register 0FA3 (4003) | | Value for register 0FA4 (4004) | | CRC Control sum |
|----------------|----------|-------------------|-------------------|-------------------|-------------------|-----------------|--------------------------------|----|--------------------------------|----|-----------------|
| | | | | | | | B1 | B0 | B1 | B0 | |
| 01 | 10 | 0F | A3 | 00 | 02 | 04 | 00 | 14 | 07 | D0 | BB 9A |

Response:

| Device address | Function | Register address | | Number of registers | | CRC Control sum |
|----------------|----------|------------------|----|---------------------|----|-----------------|
| | | B1 | B0 | B1 | B0 | |
| 01 | 10 | 0F | A3 | 00 | 02 | B2 FE |

Report identifying the device (code 11h)

Example 7 . Device identification

Request: Table 8

| Device address | Function | CRC Control sum |
|----------------|----------|-----------------|
| 01 | 11 | C0 2C |

Response:

| Device address | Function | Number of bytes | Identifier | Device status | Information field of the device software version (eg, „ND20-1.09 b-1.04” - ND20 device with software version 1.09 and bootloader version 1.04) | CRC Control sum |
|----------------|----------|-----------------|------------|---------------|--|-----------------|
| 01 | 11 | 19 | BC | FF | 4E 44 32 30 2D 31 2E 30 39 20 20 20 20 20 20 20 62 2D 31 2E 30 34 20 | DB 42 |

Map of ND20 meter registers

In the ND20 meter, data are placed in 16 and 32-bit registers. Process variables and meter parameters are placed in the address area of registers in a way depended on the variable value type. Bits in 16-bit registers are numbered from the youngest to the oldest (b0-b15). 32-bit registers include numbers of float type in IEEE-754 standard.

Table 9

| Address range | Type of value | Description |
|---------------|---------------------------|---|
| 1000 – 1077 | Integer (16 bits)/ record | Archive of the averaged power profile. The table 10 includes the register description. |
| 4000 – 4070 | Integer (16 bits) | The value is placed in one 16-bit register. The table 11 includes the register description. Registers for write and readout. |
| 6000 – 6319 | Float (2x 16 bits) | Value placed in two successive 16-bit registers. Registers include the same data as 32-bit registers from the area 7500 – 7659. Registers for readout. Sequence of bytes (1-0-3-2). |
| 6320 – 6573 | Float (2x 16 bits) | Value placed in two successive 16-bit registers. Registers include the same data as 32-bit registers from the area 7660 – 7786. Registers for readout. Sequence of bytes (1-0-3-2). |

| | | |
|-------------|-------------------|---|
| 7000 – 7319 | Float (2x16 bits) | Value placed in two successive 16-bit registers. Registers include the same data as 32-bit registers from the area 7500 – 7659. Registers for readout. Sequence of bytes (3-2-1-0). |
| 7500 – 7659 | Float (32 bits) | Value placed in one 32-bit register. The table 12 includes the register description. Registers for readout. |
| 7660 – 7786 | Float (32 bits) | Value placed in one 32-bit register. The table 12 includes the register description. Registers for readout. |
| 7800 – 8052 | Float (2x16 bits) | Value placed in two successive 16-bit registers. Registers include the same data as 32-bit registers from the area 7660 – 7786. Registers for readout. Sequence of bytes (3-2-1-0). |

Table 10

| Address of 16 bit-registers | Operations | Description |
|-----------------------------|------------|---|
| 1000 | R | Position of oldest archived mean power. |
| 1001 | R | Position of youngest archived mean power |
| 1002 | R/W | First available record – NrBL (range 1...9000) |
| 1003 | R | Year of archived mean power with number NrBL + 0 |
| 1004 | R | Month * 100 + day of archived mean power with number NrBL + 0 |
| 1005 | R | Hour * 100 + minute of archived mean power with number NrBL + 0 |
| 1006 | R | Value of archived mean power with number NrBL + 0 float type – 4 bytes in sequence 3-2-1-0 |
| 1007 | R | |
| 1008 | R | Year of archived mean power with number NrBL + 1 |
| 1009 | R | Month * 100 + day of archived mean power with number NrBL + 1 |

| | | |
|------|-----|---|
| 1010 | R | Hour * 100 + minute of archived mean power with number NrBL + 1 |
| 1011 | R | Value of archived mean power with number NrBL + 1 float type – 4 bytes in sequence 3-2-1-0 |
| 1012 | R | |
| ... | ... | ... |
| 1073 | R | Year of archived mean power with number NrBL + 14 |
| 1074 | R | Month * 100 + day of archived mean power with number NrBL + 14 |
| 1075 | R | Hour * 100 + minute of archived mean power with number NrBL + 14 |
| 1076 | R | Value of archived mean power with number NrBL + 14 float type – 4 bytes in sequence 3-2-1-0 |
| 1077 | R | |

Table 11

| Register address | Operation | Range | Description | By default |
|------------------|-----------|--------------|---|------------|
| 4000 | RW | 0...60000 | Protection - password | 0 |
| 4001 | RW | 0...900 [s] | Interlocking time of the renewed switching of the relay output on | 0 |
| 4002 | RW | 0...1440 [‰] | Ordered mean power *10 | 1000 |
| 4003 | RW | 1..10000 | Current transformer ratio | 1 |
| 4004 | RW | 1..46000 | Voltage transformer ratio *10 | 10 |

| | | | | |
|------|----|--------|---|----|
| 4005 | RW | 0..3 | <p>Synchronization of mean active power:</p> <p>0 – 15 minutes' walking window (record synchronized every 15 minutes with the clock)</p> <p>1 – measurement synchronized every 15 minutes with the clock</p> <p>2 – measurement synchronized every 30 minutes with the clock</p> <p>3 – measurement synchronized every 60minutes with the clock</p> | 0 |
| 4006 | RW | 0..22 | <p>Number of the measured harmonic/ THD</p> <p>0 – THD,</p> <p>1 – all harmonics are successively measured and placed in registers 7660-7780, 2...21 – harmonic number with energy.</p> | 0 |
| 4007 | RW | 0,1 | <p>Storage way of minimum and maximum values</p> <p>0 – without errors,</p> <p>1 – with errors</p> | 0 |
| 4008 | RW | 0,1 | <p>Way to calculate reactive power:</p> <p>0: $Q = \sqrt{S^2 - P^2}$</p> <p>1: $Q = \sum_{i=1}^k U_i * I_i * \sin(\angle U_i, I_i)$</p> <p>k – harmonic number, k = 21 for 50 Hz, k = 18 for 60 Hz</p> | 0 |
| 4009 | RW | 0,1 | <p>Way to calculate reactive energy:</p> <p>0 – inductive and capacitive energy</p> <p>1 – positive and negative energy</p> | 0 |
| 4010 | RW | 0...61 | <p>Display backlight:</p> <p>0 – disabled,</p> <p>1-60 – backlight time in seconds since the push-button pressure,</p> <p>61 – always enabled</p> | 61 |

| | | | | |
|------|----|------------------------|---|------|
| 4011 | RW | 0...4 | Erasing of watt-hour meters: 0 – without changes, 1 – erase active energy, 2 – erase reactive energy, 3 – erase energy of harmonics, 4 – erase all energy. | 0 |
| 4012 | RW | 0,1 | Erasing of mean active power P_{AV} | 0 |
| 4013 | RW | 0,1 | Erasing of the averaged power archive | 0 |
| 4014 | RW | 0,1 | Erase min and max | 0 |
| 4015 | RW | 0,1 .. 35 | Quantity on the alarm relay output (code acc. to the table 6) | 24 |
| 4016 | RW | 0 ... 9 | Output type: 0 – n-on, 1– n-off, 2 – on, 3 - oFF, 4 – H-on, 5 – H-off, 6 - A3non, 7 - A3nof, 8 - A3_on, 9 - A3_of | 0 |
| 4017 | RW | -1440..0.. 1440 [‰] | Lower alarm switching value | 990 |
| 4018 | RW | -1440..0.. 1440 [‰] | Upper alarm switching value | 1010 |
| 4019 | RW | 0...900 s | Delay of the alarm switching (for quantity $AL_n = P_{ord} - rgister$ 4015 =35, the delay occurs only when the alarm is switched on. | 0 |
| 4020 | RW | 1..2000 [10uA] | Alarm signaling support | 0 |
| 4021 | RW | 0..2 | Quantity on the continuous output no 1/ code acc. to the table 6 / | 24 |
| 4022 | RW | 0,1 | Continuous output type: 0 – 0...20 mA; 1 – 4...20 mA | 0 |
| 4023 | RW | -1440..0.. 1440 [‰] | Lower value of the input range in [‰] of the rated input range. | 0 |
| 4024 | RW | -1440..0.. 1440 [‰] | Upper value of the input range in [‰] of the rated input range. | 1000 |

| | | | | |
|------|----|------------------------------|---|------|
| 4025 | RW | -2000..0.. 2000 [10uA] | Lower output range value of the output [10 uA] | 0 |
| 4026 | RW | 1..2000 [10uA] | Upper output range value of the output [10 uA] | 2000 |
| 4027 | RW | 0..2 | Manual switching of the analog output 1: 0 – normal work, 1 – set value from the register 4026, 2- set value from the register 4027, | 0 |
| 4028 | RW | 0..24 [mA] | Analog output value when error | 24 |
| 4029 | RW | 1000.. 20000 | Number of impulses for the impulse output | 5000 |
| 4030 | RW | 1..247 | Address in the MODBUS network | 1 |
| 4031 | RW | 0..3 | Transmission mode: : 0->r8n2, 1->r8E1, 2->r8o1, 3->r8n1 | 0 |
| 4032 | RW | 0..3 | Baud rate: 0->4800, 1->9600 2->19200, 3->38400 | 1 |
| 4033 | RW | 0.1 | Bring up to date the transmission parameter change | 0 |
| 4034 | RW | 0..2359 | Hour *100 + Minutes | 0 |
| 4035 | RW | 101.. 1231 | Month * 100 + day | 101 |
| 4036 | RW | 2009.. 2100 | Year | 2009 |
| 4037 | RW | 0,1 | Record of standard parameters (together with the reset of energy and min, max, averaged power) | 0 |
| 4038 | R | 0..15258 | Imported active energy, two older bytes | 0 |
| 4039 | R | 0.. 65535 | Imported active energy, two younger bytes | 0 |

| | | | | |
|--------|----|----------|---|----------------|
| 4040 | R | 0..15258 | Exported active energy, two older bytes | 0 |
| 4041 | R | 0..65535 | exported active energy, two younger bytes | 0 |
| 4042 | R | 0..15258 | Reactive inductive energy, two older bytes | 0 |
| 4043 | R | 0..65535 | Reactive inductive energy, two younger bytes | 0 |
| 4044 | R | 0..15258 | Reactive capacitive energy, two older bytes | 0 |
| 4045 | R | 0..65535 | Reactive capacitive energy, two younger bytes | 0 |
| 4046 | R | 0..15258 | Imported harmonic active energy, two older bytes | 0 |
| 4047 | R | 0..65535 | Imported harmonic active energy, two younger bytes | 0 |
| 4048 | R | 0..15258 | Exported harmonic active energy, two older bytes | 0 |
| 4049 | R | 0..65535 | Exported harmonic active energy, two younger bytes | 0 |
| 4050 | R | 0..65535 | Status register – description below | 0 |
| 4051 | R | 0..65535 | Serial number, two older bytes | - |
| 4052 | R | 0..65535 | Serial number, two younger bytes | - |
| 4053 | R | 0..65535 | Program version (*100) | - |
| 4054 | RW | 0..65535 | Displayed parameters of standard values | 0xFFFF |
| 4055 | RW | 0..65535 | Displayed parameters of average values | 0xFFFF |
| 4056* | RW | 0..65535 | Displayed parameters of standard values 2 | 0xFFFF |
| 4057* | RW | 0..2 | Measurement mode: 0->3Ph / 4W, 1->3Ph / 4W 2-> 1Ph/2W | 577, 693, 2300 |
| 4058* | R | 0..65535 | Rated voltage x 10 | 0 |
| 4059* | R | 0..65535 | Rated current x 100 | 100, 500 |
| 4060* | R | 0..65535 | reserved | 0 |
| 4061* | R | 0..65535 | Register of status 2 - description below | 0 |
| 4062 - | R | 0..65535 | reserved | 0 |
| 4069 | RW | 0..1 | Current range 0 -1A, 1 - 5A | 1 |
| 4070 | RW | 0..2 | Voltage range 0 – 57.7V, 1 – 69.3V, 2 - 230V | 2 |

In parenthesis [], suitably is placed: resolution or unit.

* starting from version 1.09

Energy is made available in hundreds of watt-hours (var-hours) in double 16-bit register, and for this reason, one must divide them by 10 when calculating values of particular energy from registers, ie:

Imported active energy = (register 4038 value x 65536 + register 4039 value) /10 [kWh]

Exported active energy = (register 4040 value x 65536 + register 4041 value) /10 [kWh]

Reactive inductive energy = (register 4042 value x 65536 + register 4043 value) /10 [kVarh]

Reactive capacitive energy = (register 4044 value x 65536 + register 4045 value) /10 [kVarh]

Imported active harmonic energy = (register 4046 value x 65536 + register 4047 value) /10 [kWh]

Exported active harmonic energy = (register 4048 value x 65536 + register 4049 value) /10 [kWh]

Device status register (address 4050, R):

Bit 15 – „1” – damage of the non-volatile memory

Bit 7 – „1” – the interval of averaged power is not elapsed

Bit 14 – „1” – lack of calibration or erroneous calibration

Bit 6 – „1” – frequency for THD calculation beyond intervals
- 48 – 52 for frequency 50 Hz,
- 58 – 62 for frequency 60 Hz

Bit 13 – „1” – error of parameter values

Bit 5 – „1” – voltage too low for frequency measurements

Bit 12 – „1” – error of energy values

Bit 4 – „1” – too low voltage of phase C

Bit 11 – „1” – error of phase sequence

Bit 3 – „1” – too low voltage of phase B

Bit 10 – current range „0” – 1 A~;
1” – 5 A~

Bit 2 – „1” – too low voltage of phase A

Bit 9 Bit 8 Voltage range

Bit 1 – the RTC time battery is used up

0 0 57.7 V~
0 1 230 V~

Bit 0 – state of relay output „1” – On,
„0” – off

Register of status 2 - nature of the reactive power (address 4061, R):

| | |
|---|-------------------------------------|
| Bit 15 – reserved | Bit 9 – „1” – capacitive 3L |
| Bit 14 – „1” – alarm indication in phase L3 (only for alarm type: A3non, A3nof, A3_on, A3_of) | Bit 8 – „1” – capacitive L3 maximum |
| Bit 13 – „1” – alarm indication in phase L2 (only for alarm type: A3non, A3nof, A3_on, A3_of) | Bit 7 – „1” – capacitive L3 minimum |
| Bit 12 – „1” – alarm indication in phase L1 (only for alarm type: n-on, n-off, on, off) | Bit 6 – „1” – capacitive L3 |
| Bit 11 – „1” – capacitive 3L maximum | Bit 5 – „1” – capacitive L2 maximum |
| Bit 10 – „1” – capacitive 3L minimum | Bit 4 – „1” – capacitive L2 minimum |
| | Bit 3 – „1” – capacitive L2 |
| | Bit 2 – „1” – capacitive L1 maximum |
| | Bit 1 – „1” – capacitive L1 minimum |
| | Bit 0 – „1” – capacitive L1 |

Configuration register of displayed parameters of standard values (address 4054, R/W):

| | |
|---|---|
| Bit 15 ...13 – reserved | Bit 6 – „1” – displaying of capacitive passive energy |
| Bit 12 – „1” – displaying of the date | Bit 5 – „1” – displaying of inductive passive energy |
| Bit 11 – „1” – displaying of the cosine φ values | Bit 4 – „1” – displaying of exported active energy |
| Bit 10 – „1” – displaying of active exported harmonic energy/ value of current harmonic | Bit 3 – „1” – displaying of imported active energy |
| Bit 9 – „1” – displaying of active imported harmonic energy/ value of voltage harmonic | Bit 2 – „1” – displaying of tg |
| Bit 8 – „1” – displaying of THD current/ value of current harmonic | Bit 1 – „1” – displaying of PF |
| Bit 7 – „1” – displaying of THD voltage/ value of voltage harmonic | Bit 0 – „1” – displaying of phase-to-phase voltages |

Configuration register of displayed parameters of standard values 2
(address 4056, R/W):

| | |
|--|---|
| Bit 15 ...6 – reserved | Bit 2 – „1” – displaying of phase active powers |
| Bit 5 – „1” – displaying of power ΣP , ΣQ , ΣS | Bit 1 – „1” – displaying of phase currents |
| Bit 4 – „1” – displaying of phase apparent powers | Bit 0 – „1” – displaying of phase voltages |
| Bit 3 – „1” – displaying of phase reactive powers | |

Configuration register of displayed parameters of average values
(address 4055, R/W):

| | |
|---|--|
| Bit 15 ...14 – reserved | Bit 5 – „1” – displaying of time |
| Bit 13 – „1” – displaying of mean THD of current | Bit 4 – „1” – displaying of average cosine φ |
| Bit 12 – „1” – displaying of mean THD of voltage | Bit 3 – „1” – displaying of average active power |
| Bit 11 – „1” – displaying of power ΣS | Bit 2 – „1” – displaying of average tg |
| Bit 10 – „1” – displaying of power ΣQ | Bit 1 – „1” – displaying of average PF |
| Bit 9 – „1” – displaying of power ΣP | Bit 0 – „1” – displaying of current in neutral wire |
| Bit 8 – „1” – displaying of average current | |
| Bit 7 – „1” – displaying of ordered power consumption | |
| Bit 6 – „1” – displaying of frequency | |

Table 12

| Address of 16-bit registers | Address of 32-bit registers | Operation | Description | Unit | 3Ph/4W | 3Ph/3W | 3Ph/2W |
|-----------------------------|-----------------------------|-----------|-------------------------------|------|--------|--------|--------|
| 6000/7000 | 7500 | R | Voltage of phase L1 | V | √ | x | √ |
| 6002/7002 | 7501 | R | Current in phase L1 | A | √ | √ | √ |
| 6004/7004 | 7502 | R | Active power of phase L1 | W | √ | x | √ |
| 6006/7006 | 7503 | R | Reactive power of phase L1 | var | √ | x | √ |
| 6008/7008 | 7504 | R | Apparent power of phase L1 | VA | √ | x | √ |
| 6010/7010 | 7505 | R | Power factor (PF) of phase L1 | - | √ | x | √ |
| 6012/7012 | 7506 | R | Tg ϕ factor of phase L1 | - | √ | x | √ |
| 6014/7014 | 7507 | R | Voltage of phase L2 | V | √ | x | x |
| 6016/7016 | 7508 | R | Current in phase L2 | A | √ | √ | x |
| 6018/7018 | 7509 | R | Active power of phase L2 | W | √ | x | x |
| 6020/7020 | 7510 | R | Reactive power of phase L2 | var | √ | x | x |
| 6022/7022 | 7511 | R | Apparent power of phase L2 | VA | √ | x | x |
| 6024/7024 | 7512 | R | Power factor (PF) of phase L2 | - | √ | x | x |
| 6026/7026 | 7513 | R | Tg ϕ factor of phase L2 | - | √ | x | x |
| 6028/7028 | 7514 | R | Voltage of phase L3 | V | √ | x | x |
| 6030/7030 | 7515 | R | Current in phase L3 | A | √ | √ | x |
| 6032/7032 | 7516 | R | Active power of phase L3 | W | √ | x | x |
| 6034/7034 | 7517 | R | Reactive power of phase L3 | var | √ | x | x |
| 6036/7036 | 7518 | R | Apparent power of phase L3 | VA | √ | x | x |
| 6038/7038 | 7519 | R | Power factor (PF) of phase L3 | - | √ | x | x |
| 6040/7040 | 7520 | R | Tg ϕ factor of phase L3 | - | √ | x | x |

| | | | | | | | |
|-----------|------|---|---|-------|---|---|---|
| 6042/7042 | 7521 | R | Mean 3-phase voltage | V | √ | x | x |
| 6044/7044 | 7522 | R | Mean 3-phase current | A | √ | √ | x |
| 6046/7046 | 7523 | R | 3-phase active power (P1+P2+P3) | W | √ | √ | x |
| 6048/7048 | 7524 | R | 3-phase reactive power (Q1+Q2+Q3) | var | √ | √ | x |
| 6050/7050 | 7525 | R | 3-phase apparent power (S1+S2+S3) | VA | √ | √ | x |
| 6052/7052 | 7526 | R | Mean power factor (PF) | - | √ | √ | x |
| 6054/7054 | 7527 | R | Mean $Tg \phi$ factor of phase L1 | - | √ | √ | x |
| 6056/7056 | 7528 | R | Frequency | Hz | √ | √ | x |
| 6058/7058 | 7529 | R | Phase-to-phase voltage L1-2 | V | √ | √ | x |
| 6060/7060 | 7530 | R | Phase-to-phase voltage L2-3 | V | √ | √ | x |
| 6062/7062 | 7531 | R | Phase-to-phase voltage L3-1 | V | √ | √ | x |
| 6064/7064 | 7532 | R | Mean phase-to-phase voltage | V | √ | √ | x |
| 6066/7066 | 7533 | R | 3-phase 15, 30, 60 minutes' active Power (P1 + P2 + P3) | W | √ | √ | √ |
| 6068/7068 | 7534 | R | Harmonic U1 / THD U1 | V / % | √ | x | √ |
| 6070/7070 | 7535 | R | Harmonic U2 / THD U2 | V / % | √ | x | x |
| 6072/7072 | 7536 | R | Harmonic U3 / THD U3 | V / % | √ | x | x |
| 6074/7074 | 7537 | R | Harmonic I1 / THD I1 | A / % | √ | x | √ |
| 6076/7076 | 7538 | R | Harmonic I2 / THD I2 | A / % | √ | x | x |
| 6078/7078 | 7539 | R | Harmonic I3 / THD I3 | A / % | √ | x | x |
| 6080/7080 | 7540 | R | Cosinus of angle between U1 and I1 | - | √ | x | x |
| 6082/7082 | 7541 | R | Cosinus of angle between U2 and I2 | - | √ | x | x |
| 6084/7084 | 7542 | R | Cosinus of angle between U3 and I3 | - | √ | x | x |

| | | | | | | | |
|-----------|------|---|---|-----------|---|---|----|
| 6086/7086 | 7543 | R | 3-phase mean cosinus | - | √ | √ | x |
| 6088/7088 | 7544 | R | Angle between U1 and I1 | ° | √ | x | √ |
| 6090/7090 | 7545 | R | Angle between U2 i I2 | ° | √ | x | x |
| 6092/7092 | 7546 | R | Angle between U3 i I3 | ° | √ | x | x |
| 6094/7094 | 7547 | R | Current in neutral wire (calculated from vectors) | A | √ | x | x |
| 6096/7096 | 7548 | R | Imported 3-phase active energy (number of overflows in register 7549, reset after exceeding 99999999.9 kWh) | 100 MWh | √ | √ | P1 |
| 6098/7098 | 7549 | R | Imported 3-phase active energy (counter totting up to 99999.9 kWh) | kWh | √ | √ | P1 |
| 6100/7100 | 7550 | R | Exported 3-phase active energy (number of overflows in register 7551, reset after exceeding 99999999.9 kWh) | 100 MWh | √ | √ | P1 |
| 6102/7102 | 7551 | R | Exported 3-phase active energy (counter totting up to 99999.9 kWh) | kWh | √ | √ | P1 |
| 6104/7104 | 7552 | R | 3-phase reactive inductive energy (number of overflows in register 7553, reset after exceeding 99999999.9 kVarh) | 100 Mvarh | √ | √ | Q1 |
| 6106/7106 | 7553 | R | 3-phase reactive inductive energy (counter totting up to 99999.9 kVarh) | kvarh | √ | √ | Q1 |
| 6108/7108 | 7554 | R | 3-phase reactive capacitive energy (number of overflows in register 7555, reset after exceeding 99999999.9 kVarh) | 100 Mvarh | √ | √ | Q1 |

| | | | | | | | |
|-----------|------|---|--|---------|---|---|----|
| 6110/7110 | 7555 | R | 3-phase reactive capacitive energy (counter totting up to 99999.9 kVarh) | kvarh | √ | √ | Q1 |
| 6112/7112 | 7556 | R | Imported 3-phase active harmonic energy (number of overflows in register 7557, reset after exceeding 99999999.9 kWh) | 100 MWh | √ | x | x |
| 6114/7114 | 7557 | R | Imported 3-phase active harmonic energy (counter totting up to 99999.9 kWh) | kWh | √ | x | x |
| 6116/7116 | 7558 | R | Exported 3-phase active harmonic energy (number of overflows in register 7559, reset after exceeding 99999999.9 kWh) | 100 MWh | √ | x | x |
| 6118/7118 | 7559 | R | Exported 3-phase active harmonic energy (counter totting up to 99999.9 kWh) | kWh | √ | x | x |
| 6120/7120 | 7560 | R | Time – hours, minutes | - | √ | √ | √ |
| 6122/7122 | 7561 | R | Time – month, day | - | √ | √ | √ |
| 6124/7124 | 7562 | R | Time – year | - | √ | √ | √ |
| 6126/7126 | 7563 | R | Analog output value | mA | √ | √ | √ |
| 6128/7128 | 7564 | R | Voltage L1 min | V | √ | x | √ |
| 6130/7130 | 7565 | R | Voltage L1 max | V | √ | x | √ |
| 6132/7132 | 7566 | R | Voltage L2 min | V | √ | x | x |
| 6134/7134 | 7567 | R | Voltage L2 max | V | √ | x | x |
| 6136/7136 | 7568 | R | Voltage L3 min | V | √ | x | x |
| 6138/7138 | 7569 | R | Voltage L3 max | V | √ | x | x |
| 6140/7140 | 7570 | R | Current L1 min | A | √ | √ | √ |
| 6142/7142 | 7571 | R | CurrentL1 max | A | √ | √ | √ |

| | | | | | | | |
|-----------|------|---|-----------------------------------|-----|---|---|---|
| 6144/7144 | 7572 | R | Current L2 min | A | √ | √ | x |
| 6146/7146 | 7573 | R | Current L2 max | A | √ | √ | x |
| 6148/7148 | 7574 | R | Current L3 min | A | √ | √ | x |
| 6150/7150 | 7575 | R | Current L3 max | A | √ | √ | x |
| 6152/7152 | 7576 | R | Active power L1 min | W | √ | x | √ |
| 6154/7154 | 7577 | R | Active power L1 max | W | √ | x | √ |
| 6156/7156 | 7578 | R | Active power L2 min | W | √ | x | x |
| 6158/7158 | 7579 | R | Active power L2 max | W | √ | x | x |
| 6160/7160 | 7580 | R | Active power L3 min | W | √ | x | x |
| 6162/7162 | 7581 | R | Active power L3 max | W | √ | x | x |
| 6162/7164 | 7582 | R | Reactive power L1 min | var | √ | x | √ |
| 6166/7166 | 7583 | R | Reactive power L1 max | var | √ | x | √ |
| 6168/7168 | 7584 | R | Reactive power L2 min | var | √ | x | x |
| 6170/7170 | 7585 | R | Reactive power L2 max | var | √ | x | x |
| 6172/7172 | 7586 | R | Reactive power L3 min | var | √ | x | x |
| 6174/7174 | 7587 | R | Reactive power L3 max | var | √ | x | x |
| 6176/7176 | 7588 | R | Apparent power L1 min | VA | √ | x | √ |
| 6178/7178 | 7589 | R | Apparent power L1 max | VA | √ | x | √ |
| 6180/7180 | 7590 | R | Apparent power L2 min | VA | √ | x | x |
| 6182/7182 | 7591 | R | Apparent power L2 max | VA | √ | x | x |
| 6184/7184 | 7592 | R | Apparent power L3 min | VA | √ | x | x |
| 6186/7186 | 7593 | R | Apparent power L3 max | VA | √ | x | x |
| 6188/7188 | 7594 | R | Power factor (PF) of phase L1 min | - | √ | x | √ |
| 6190/7190 | 7595 | R | Power factor (PF) of phase L1 max | - | √ | x | √ |
| 6192/7192 | 7596 | R | Power factor (PF) of phase L2 min | - | √ | x | x |
| 6194/7194 | 7597 | R | Power factor (PF) of phase L2 max | - | √ | x | x |
| 6196/7196 | 7598 | R | Power factor (PF) of phase L3 min | - | √ | x | x |
| 6198/7198 | 7599 | R | Power factor (PF) of phase L3 max | - | √ | x | x |

| | | | | | | | |
|-----------|------|---|----------------------------------|-----|---|---|---|
| 6200/7200 | 7600 | R | Tg ϕ factor of phase L1 min | - | √ | x | √ |
| 6202/7202 | 7601 | R | Tg ϕ factor of phase L1 max | - | √ | x | √ |
| 6204/7204 | 7602 | R | Tg ϕ factor of phase L2 min | - | √ | x | x |
| 6206/7206 | 7603 | R | Tg ϕ factor of phase L2 max | - | √ | x | x |
| 6208/7208 | 7604 | R | Tg ϕ factor of phase L3 min | - | √ | x | x |
| 6210/7210 | 7605 | R | Tg ϕ factor of phase L3 max | - | √ | x | x |
| 6212/7212 | 7606 | R | Phase-to-phase voltage L1-2 min | V | √ | √ | x |
| 6214/7214 | 7607 | R | Phase-to-phase voltage L1-2 max | V | √ | √ | x |
| 6216/7216 | 7608 | R | Phase-to-phase voltage L2-3 min | V | √ | √ | x |
| 6218/7218 | 7609 | R | Phase-to-phase voltage L2-3 max | V | √ | √ | x |
| 6220/7220 | 7610 | R | Phase-to-phase voltage L3-1 min | V | √ | √ | x |
| 6222/7222 | 7611 | R | Phase-to-phase voltage L3-1 max | V | √ | √ | x |
| 6224/7224 | 7612 | R | Mean 3-phase voltage min | V | √ | √ | x |
| 6226/7226 | 7613 | R | Mean 3-phase voltage max | V | √ | √ | x |
| 6228/7228 | 7614 | R | Mean 3-phase current min | A | √ | √ | x |
| 6230/7230 | 7615 | R | Mean 3-phase current max | A | √ | √ | x |
| 6232/7232 | 7616 | R | 3-phase active power min | W | √ | √ | x |
| 6234/7234 | 7617 | R | 3-phase active power max | W | √ | √ | x |
| 6236/7236 | 7618 | R | 3-phase reactive power min | var | √ | √ | x |
| 6238/7238 | 7619 | R | 3-phase reactive power max | var | √ | √ | x |
| 6240/7240 | 7620 | R | 3-phase apparent power min | VA | √ | √ | x |

| | | | | | | | |
|-----------|------|---|--------------------------------------|-------|---|---|---|
| 6242/7242 | 7621 | R | 3-phase apparent power max | VA | √ | √ | x |
| 6242/7244 | 7622 | R | Mean power factor (PF) min | - | √ | √ | x |
| 6246/7246 | 7623 | R | Mean power factor (PF) max | - | √ | √ | x |
| 6248/7248 | 7624 | R | Mean Tgφ factor min | - | √ | √ | x |
| 6250/7250 | 7625 | R | Mean Tgφ factor max | - | √ | √ | x |
| 6252/7252 | 7626 | R | Frequency min | Hz | √ | √ | √ |
| 6254/7254 | 7627 | R | Frequency max | Hz | √ | √ | √ |
| 6256/7256 | 7628 | R | Mean phase-to-phase voltage min | V | √ | √ | x |
| 6258/7258 | 7629 | R | Mean phase-to-phase voltage max | V | √ | √ | x |
| 6260/7260 | 7630 | R | Mean active power min | W | √ | √ | √ |
| 6262/7262 | 7631 | R | Mean reactive power max | W | √ | √ | √ |
| 6264/7264 | 7632 | R | Harmonic U1 / THD U1 min | V / % | √ | x | √ |
| 6266/7266 | 7633 | R | Harmonic U1 / THD U1 max | V / % | √ | x | √ |
| 6268/7268 | 7634 | R | Harmonic U2 / THD U2 min | V / % | √ | x | x |
| 6270/7270 | 7635 | R | Harmonic U2 / THD U2 max | V / % | √ | x | x |
| 6272/7272 | 7636 | R | Harmonic U3 / THD U3 min | V / % | √ | x | x |
| 6274/7274 | 7637 | R | Harmonic U3 / THD U3 max | V / % | √ | x | x |
| 6276/7276 | 7638 | R | Harmonic I1 / THD I1 min | A / % | √ | x | √ |
| 6278/7278 | 7639 | R | Harmonic I1 / THD I1 max | A / % | √ | x | √ |
| 6280/7280 | 7640 | R | Harmonic I2 / THD I2 min | A / % | √ | x | x |
| 6282/7282 | 7641 | R | Harmonic I2 / THD I2 max | A / % | √ | x | x |
| 6284/7284 | 7642 | R | Harmonic I3 / THD I3 min | A / % | √ | x | x |
| 6286/7286 | 7643 | R | Harmonic I3 / THD I3 max | A / % | √ | x | x |
| 6288/7288 | 7644 | R | Cosinus of angle between U1 i I1 min | - | √ | x | √ |

| | | | | | | | |
|-----------|------|-----|--------------------------------------|-----|---|---|---|
| 6290/7290 | 7645 | R | Cosinus of angle between U1 i I1 max | | √ | x | √ |
| 6292/7292 | 7646 | R | Cosinus of angle between U2 i I2 min | - | √ | x | x |
| 6294/7294 | 7647 | R | Cosinus of angle between U2 i I2 max | - | √ | x | x |
| 6296/7296 | 7648 | R | Cosinus of angle between U3 i I3 min | - | √ | x | x |
| 6298/7298 | 7649 | R | Cosinus of angle between U3 i I3 max | - | √ | x | x |
| 6300/7300 | 7650 | R | Mean 3-phase cos min | - | √ | √ | x |
| 6302/7302 | 7651 | R | Mean 3-phase cos max | - | √ | √ | x |
| 6304/7304 | 7652 | R | Angle between U1 i I1 min | ° | √ | x | √ |
| 6306/7306 | 7653 | R | Angle between U1 i I1 max | ° | √ | x | √ |
| 6308/7308 | 7654 | R | Angle between U2 i I2 min | ° | √ | x | x |
| 6310/7310 | 7655 | R | Angle between U2 i I2 max | ° | √ | x | x |
| 6312/7312 | 7656 | R | Angle between U3 i I3 min | ° | √ | x | x |
| 6314/7314 | 7657 | R | Angle between U3 i I3 max | ° | √ | x | x |
| 6316/7316 | 7658 | R | Current in neutral wire min | A | √ | x | x |
| 6318/7318 | 7659 | R | Current in neutral wire max | A | √ | x | x |
| 6320/7800 | 7660 | R | U1 – harmonic 2 | % | √ | x | √ |
| ... | ... | ... | ... | ... | | | |
| 6358/7838 | 7679 | R | U1 - harmonic 21 | % | √ | x | √ |
| 6360/7840 | 7680 | R | U2 - harmonic 2 | % | √ | x | x |
| ... | ... | ... | ... | ... | | | |
| 6398/7878 | 7699 | R | U2 - harmonic 21 | % | √ | x | x |
| 6400/7880 | 7700 | R | U3 - harmonic 2 | % | √ | x | x |
| ... | ... | ... | ... | ... | | | |
| 6438/7918 | 7719 | R | U3 - harmonic 21 | % | √ | x | x |

| | | | | | | | |
|-----------|------|-----|------------------------------|-----|---|---|----|
| 6440/7920 | 7720 | R | I1 - harmonic 2 | % | √ | x | √ |
| ... | ... | ... | ... | ... | | | |
| 6478/7958 | 7739 | R | I1 - harmonic 21 | % | √ | x | √ |
| 6480/7960 | 7740 | R | I2 - harmonic 2 | % | √ | x | x |
| ... | ... | ... | ... | ... | | | |
| 6518/7998 | 7759 | R | I2 - harmonic 21 | % | √ | x | x |
| 6520/8000 | 7760 | R | I3 - harmonic 2 | % | √ | x | x |
| ... | ... | ... | ... | ... | | | |
| 6558/8038 | 7779 | R | I3 - harmonic 21 | % | √ | x | x |
| 6560/8040 | 7780 | R | Consumed ordered power | % | √ | x | P1 |
| 6562/8042 | 7781 | R | 3-phase harmonic U/THD U | V/% | √ | x | x |
| 6564/8044 | 7782 | R | 3-phase harmonic I/THD I | A/% | √ | x | x |
| 6566/8046 | 7783 | R | 3-phase harmonic U/THD U min | V/% | √ | x | x |
| 6568/8048 | 7784 | R | 3-phase harmonic U/THD U max | V/% | √ | x | x |
| 6570/8050 | 7785 | R | 3-phase harmonic I/THD I min | A/% | √ | x | x |
| 6572/8052 | 7786 | R | 3-phase harmonic I/THD I max | A/% | √ | x | x |

In case of a lower exceeding the value -1e20 is written in, however after an upper exceeding or error occurrence, the value 1e20 is written.

9. ERROR CODES

During the meter operation, messages about errors can occur. Reasons of errors are presented below.

Err1 -when the voltage or current is too small when measuring:
- P_{Fi} , $\text{tg}\varphi_i$, \cos , THD, harmonic below 10% U_n ,
- P_{Fi} , $\text{tg}\varphi_i$, \cos , below 1% I_n ,
- THD, harmonic below 10% I_n ,
- f below 10% U_n ,
- $I_{(N)}$, below 10% I_n ;

bAd Freq - When measuring harmonics and THD, if the frequency value is beyond the interval 48 – 52 Hz for 50Hz and 58 – 62 for 60 Hz;

Err bat is displayed when the battery of the internal RTC clock is used up. The measurement is carried out after switching the supply on and every day at midnight. One can disable the message by the  push-button. The disabled message remains inactive till the renewed switching of the meter on.

Err CAL, Err EE - are displayed when the meter memory is damaged. The meter must be sent to the manufacturer.

Err PAr - are displayed when operating parameters in the meter are incorrect. One must restore manufacturer's parameters (from the menu level or through RS-485). One can disable the message by the  push-button.

Err Enrg - are displayed when energy values in the meter are incorrect. One can disable the message by the  push-button. Incorrect energy values are reset.

Err L2 L3

error of phase sequence, one must interchange the connection of phase 2 and phase 3. One can disable the message by the  push-button. Each time you power up, the message will be displayed again.

----- or ----- - lower overflow. The measured value is smaller than the lower measuring quantity range.

----- or ----- - upper overflow. The measured value is higher than the upper measuring quantity range or measurement error.

10. TECHNICAL DATA

Measuring ranges and admissible basic errors

Table 13

| Measured value | Indication range* | Measuring range | L1 | L2 | L3 | Σ | Basic error |
|--|--|--|----|----|----|---|-------------|
| Current In 1 A 5 A | 0.00 ... 12 kA 0.00 ... 60 kA | 0.002 ... 1.200 A~ 0.010 ... 6.000 A~ | • | • | • | | ±0.2% r |
| Voltage L-N 57.7 V 69.3 V 230 V | 0.0 .. 318.0 kV 0.0 .. 382.5 kV 0.0 .. 1.269 MV | 2.8 ... 70.0 V~ 3.4 .. 84 V~ 11.5 ... 276 V~ | • | • | • | | ±0.2% r |
| Voltage L-L 100 V 120 V 400 V | 0.0 ... 552.0 kV 0.0 .. 662.0 kV 0.0 ... 2.20 MV | 5 ... 120 V~ 6.0 .. 144 V~ 20 ... 480 V~ | • | • | • | | ±0.5% r |
| Frequency | 47.0 .. 63.0 Hz | 47.0...63.0 Hz | • | • | • | | ±0.2%mv |
| Active power | -9999 MW .. 0.00 W .. 9999 MW | -1.65 kW...1.4 W...1.65 kW | • | • | • | • | ±0.5% r |
| Reactive power | -9999 Mvar .. 0.00 var .. 9999 Mvar | -1.65 kvar...1.4 var...1.65 kvar | • | • | • | • | ±0.5% r |
| Apparent power | 0.00 VA .. 9999 MVA | 1.4 VA...1.65 kVA | • | • | • | • | ±0.5% r |
| Power factor PF | -1 .. 0.. 1 | -1...0...1 | • | • | • | • | ±1% r |
| Tangent φ factor | -10.2...0...10.2 | -1.2...0...1.2 | • | • | • | • | ±1% r |
| Cosinus Φ | -1... 1 | -1... 1 | • | • | • | • | ±1% r |
| φ | -180 ... 180 | -180 ... 180 | • | • | • | | ±0.5% r |
| Imported active energy | 0 .. 99 999 999.9 kWh | | | | | • | ±0.5% r |
| Exported active energy | 0 .. 99 999 999.9 kWh | | | | | • | ±0.5% r |
| Reactive inductive energy | 0 .. 99 999 999.9 kvarh | | | | | • | ±0,5% |
| Reactive capacitive energy | 0 .. 99 999 999.9 kvarh | | | | | • | ±0,5% |
| THD | 0 .. 100% | 0 .. 100% | • | • | • | | ±5% |

* Depending on the set tr_U ratio (ratio of the voltage transformer: 0.1...4600.0)

and tr_I ratio (ratio of the current transformer: 1...10000)

r - of the range

mv - of the measured value

Caution! For the correct current measurement the presence of a voltage higher than 0.05 Un is required at least in one of the phase

| | |
|--|---|
| Power input: | |
| - in supply circuit | $\leq 6 \text{ VA}$ |
| - in voltage circuit | $\leq 0.05 \text{ VA}$ |
| - in current circuit | $\leq 0.05 \text{ VA}$ |
| Display field: | dedicated display LCD 3.5" |
| Relay output: | relay, voltageless NO contacts load capacity 250 V~/ 0.5 A ~ |
| Analog output: | current 0(4) ... 20 ... 24 mA load resistance $\leq 250 \Omega$ resolution 0.01 % of the range basic error 0.2% |
| Serial interface RS-485: | address 1...247; mode: 8N2,8E1, 8O1,8N1; baud rate: 4.8, 9.6, 19.2, 38.4 kbit/s transmission protocol: Modbus RTU response time: 600 ms |
| Energy impulse output | output of OC type (NPN), passive of class A , acc.to EN 62053-31 supply voltage 18 .. 27 V, current 10 .. 27 mA |
| Constant of OC type output impulse: | 1000 - 20000 imp./kWh independently of set tr_U, tr_I ratios |
| Protection grade ensured by the casing: | |
| - from frontal side | IP 65 |
| - from terminal side | IP 20 |
| Weight | 0.3 kg |
| Overall dimensions | 96 x 96 x 77 mm |

Reference and rated operating conditions

- supply voltage 85..253 V a.c. (40...400) Hz or
90..300 V d.c.
20..40 V a.c. (40...400) Hz or
20..60 V d.c.
- input signal: 0...0.002...1.2 I_n ; 0.05...1.2 U_n
for current, voltage
0...0.002...1.2 I_n ; 0...0.1...1.2 U_n
for power factors P_{fi} , $t_{\phi i}$
frequency 47...63 Hz
sinusoidal (THD \leq 8%)
- power factor -1...0...1
- ambient temperature -25...23...+55°C
- storage temperature -30...+70°C
- relative humidity 25...95% (condensation inadmissible)
- admissible peak factor:
 - current intensity 2
 - voltage 2
- external magnetic field 0...40...400 A/m
- short duration overload (5 s)
 - voltage inputs 2 U_n (max. 1000 V)
 - current inputs 10 I_n
- operating position any
- preheating time 5 min.

Battery of the real time clock: CR2032

Additional errors:

in % of the basic error

- from frequency of input signals < 50%
- from ambient temperature changes < 50%/10°C
- for THD > 8% < 100%

Standards fulfilled by the meter:

Electromagnetic compatibility:

- noise immunity acc. to EN 61326-1 Class A:Industrial env.
- noise emissions acc. to EN 61000-6-4

Safety requirements:

according to EN 61010 -1 standard

- isolation between circuits: basic
- installation category: III
- pollution level: 2
- maximum phase-to-earth voltage:
 - for supply and measuring circuits 300 V
 - for remaining circuits 50 V
- altitude above sea level: < 2000 m.

11. ORDERING CODES

Table 14

| | | | | | | | |
|---|----------|----------|----------|----------|-----------|----------|----------|
| Meter of network parameters ND20 | 2 | 2 | 1 | X | XX | X | X |
| Current input In: | | | | | | | |
| 1A/ 5 A | 2 | | | | | | |
| Voltage input (phase/phase-to-phase) Un: | | | | | | | |
| 3 x 57.7/100 V, 3 x 69.3/120 V, 3 x 230/400 V | 2 | | | | | | |
| Analog current output: | | | | | | | |
| with programmable output 0(4) ... 20 mA | | | 1 | | | | |
| Supply voltage: | | | | | | | |
| 85..253 V a.c., 90..300 V d.c. | | | | 1 | | | |
| 20..40 V a.c., 20..60 V d.c. | | | | 2 | | | |
| Kind of version: | | | | | | | |
| standard | | | | | 00 | | |
| custom-made* | | | | | XX | | |
| Language: | | | | | | | |
| Polish/ English | | | | | | M | |
| Russion | | | | | | R | |
| other* | | | | | | X | |
| Acceptance tests: | | | | | | | |
| with an extra quality inspection certificate | | | | | | | 1 |
| with calibartion certificate | | | | | | | 2 |
| acc. to customer's requirements* | | | | | | | X |

* - After agreeing with the manufacturer.

Example of Order:

When ordering please respect successive code numbers.

The code: **ND20 221100M1** means:

ND20 – meter of network parameters of ND20 type

2 – programmable current input ranges: 1 A or 5 A,

2 – programmable voltage input ranges 3 x 57.7/100 V, 3 x 69.3/120 V,
3 x 230/400 V

1 – with programmable analog output,

1 – supply voltage: 85...253 V a.c., 90..300 V d.c.

00 – standard version

M – Polish/English language version,

1 – with an extra quality inspection certificate.



LUMEL S.A.

ul. Sulechowska 1, 65-022 Zielona Góra, POLAND
tel.: +48 68 45 75 100, fax +48 68 45 75 508
www.lumel.com.pl

Export department:

tel.: (+48 68) 45 75 139, 45 75 233, 45 75 321, 45 75 386
fax.: (+48 68) 32 54 091
e-mail: export@lumel.com.pl

ND20-09G