

LUMEL

# SYSTEM FOR INJECTION MOULDS WITH HEATED CHANNELS SR11 TYPE



USER'S MANUAL

CE



## CONTENTS

<b>1. SR11 SYSTEM .....</b>	<b>4</b>
1.1. System Application .....	4
1.2. System Set .....	4
1.3. Design Description .....	5
1.4. Installation and Start .....	10
1.5. Way of Serial Interface Connection .....	22
1.6. Technical Data of the System .....	23
<b>2. USER'S MANUAL OF BR11 CONTROLLER .....</b>	<b>25</b>
2.1. Application .....	25
2.2. Start of Work .....	26
2.3. Servicing .....	27
2.3.1. Functions of Indicators .....	27
2.3.2. Functions of Buttons .....	29
2.4. Operating modes of the controller .....	30
2.4.1. Soft Start .....	30
2.4.2. Autotuning .....	30
2.4.3. Automatic Control .....	30
2.4.4. Mode with Decreased Temperature .....	31
2.4.5. Manual Control .....	32
2.4.6. Controller Operation at Voltage Supply Decay .....	32
2.5. Review and Change of Parameters .....	33
2.6. Alarm States .....	37
2.6.1. Alarms Signalled During the Work .....	37
2.6.2. Errors Detected After Connecting the Supply .....	38
2.6.3. Replacement of Fuses in the Controller .....	39
2.7. Communication with the Master System .....	40
2.7.1. Introduction .....	40
2.7.2. Function Description .....	40
2.7.3. Codes of Transmission Errors .....	44
2.7.4. List of Registers .....	45
2.8. Technical Data of the Controller .....	48
<b>3. ORDER CODES OF THE SR11 SYSTEM .....</b>	<b>51</b>
<b>4. MAINTENANCE AND WARRANTY .....</b>	<b>54</b>

# 1. SR11 SYSTEM

---

---

## 1.1. System Application

The SR11 system is destined for the temperature control in injection moulds with heated channels and for other systems in plastics processing. It is composed of BR11 controllers and a set of connecting cables. The RS-485/MODBUS digital interface and the software on PC enable the supervision of the data archiving process (the LUMEL 3000 software for data archiving and visualisation must be ordered separately).

The Fuzzy Logic algorithm ensures a high accuracy of the temperature control and an optimal energy consumption.

The function of softstart and leakage current control warrant the reliability of heaters. During the machine operation break, a decreased temperature is maintained, what enables a fast start.

## 1.2. System Set

The SR11 system is composed of:

- SR11 system, ordered acc. to the SR11 order code in the table 7 - 1 set
- connection set, ordered acc to the ZP11 order code in the table 8 - acc. to needs
- set of sockets and plugs for the mould, ordered acc. to the GP11 order code in the table 9 - acc. to needs
- BR11WIZ - configuration program of the controller through RS-485 - 1 pc (for versions with the interface)
- warranty card - 1 pc.

When unpacking the system, please check whether the type and version code on the data plate correspond to the order code.

### 1.3. Design Description

The SR11 system is composed of BR11 controllers situated in one housing and connected to the mould with heated channels by means of a dedicated ZP11 connection set.

The housing in the shape of a cassette, ensures appropriate exploitation conditions and the required protection degree against electric shocks. Multiple connectors ensure an easy connection with the mould.

Connecting cables of a special design have been applied in the SR11 system (fig. 1 and 2).

In SR11-11X1X, SR11-3XX1X, SR11-6XX1X and SR11-8XX1X systems, thermocouple and heater wires are led in a common bundle and shielded by a metallic shield connected to the earth potential.

Signalling wires of SR11-6XX2X and SR11-8XX2X systems are led in separate cables, also shielded.

Sensors are connected by compensating wires.

To connect the mould to the connection set, GP11 socket sets are optionally offered.

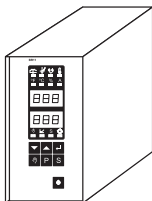

*Fig.1. Connection set to the SR11-11X1X system*

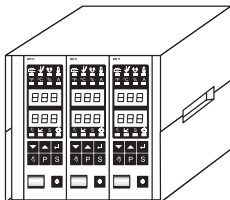

*Fig.2. Connection set to SR11-3XX1X, SR11-6XXXX and SR11-8XXXX systems*

SR11-11XXX



SR11-3XXXX



SR11-6XXXX

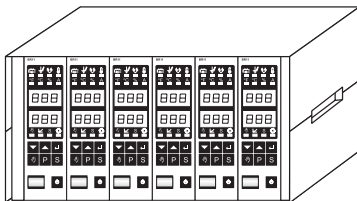

SR11-8XXXX

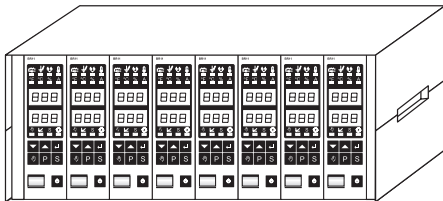
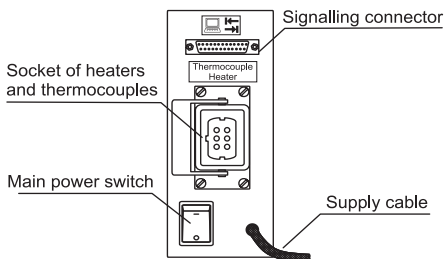

*Fig.3. View of individual versions of the SR11 system.*

On the rear side of the SR11 system there are the connection cable to the injection mould and the DB-25 signalling connector to connect the RS-485 interface, the logic input and alarm relay contact outputs. For SR11-6XXXX and SR11-8XXXX systems versions with separate connector of heaters and thermocouples are accessible, and with a common connector of heaters and thermocouples (SR11-6XX1X, SR11-8XX1X).

In SR11-11XXX and SR11-3XXXX systems, only versions with common thermocouple and heater wires are accessible.

The lay-out of connectors for system versions are shown on fig. 4, 5, 6 and 7.



*Fig.4. Lay-out of SR11-1XXXX system connectors.*

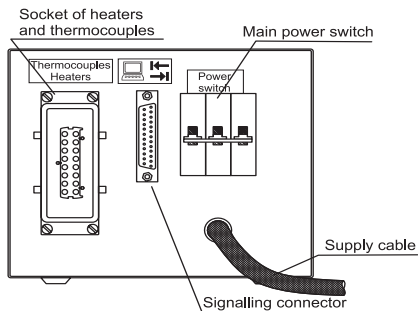

*Fig.5 Lay-out of SR11-3XX1X system connectors.*

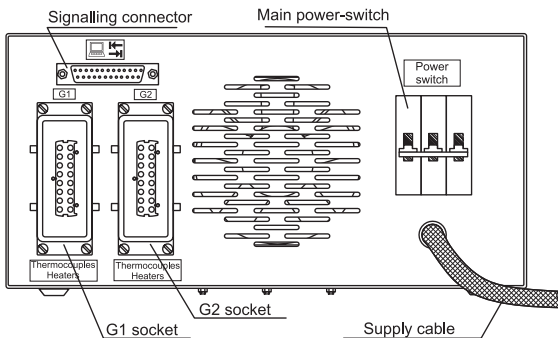

*Fig.6. Lay-out of SR11-6XX1X system connectors.*

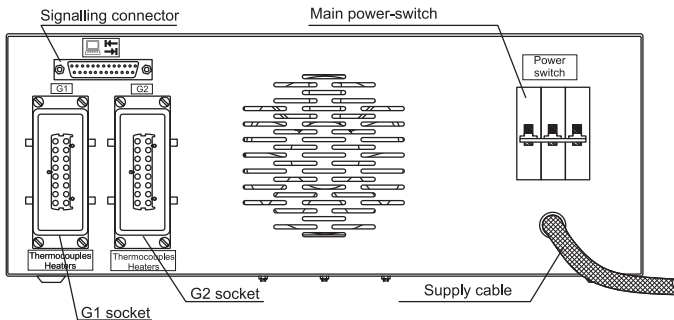

*Fig.7. Lay-out of SR11-8XX1X system connectors.*



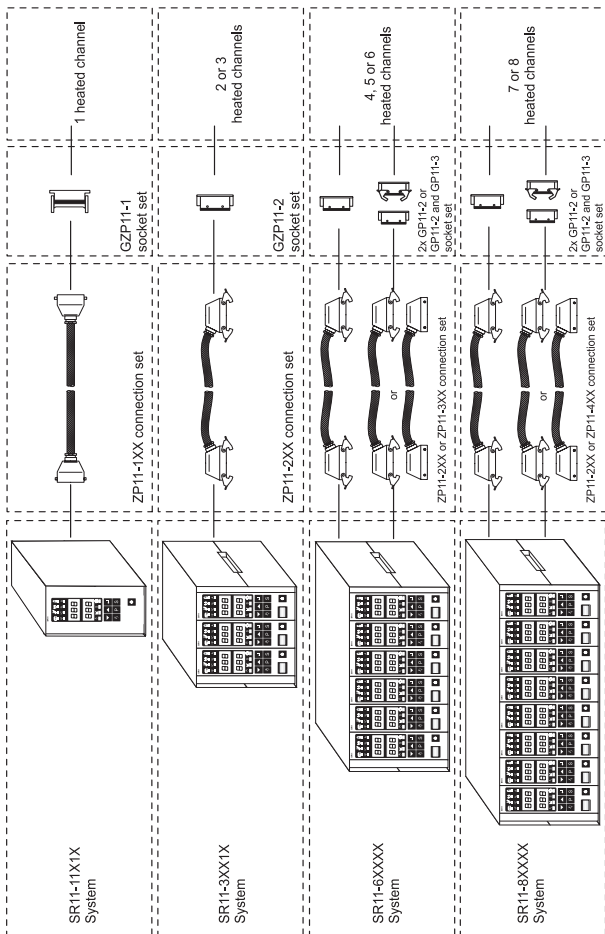

Fig. 8. Completion of the SR11 system with ZP11 connector sets.

## 1.4. Installation and Start

The installation of the SR11 system should be made by an authorized operator.

The SR11 system should be situated in a place enabling a safe service of the injection moulding press and an easy service and observation of the controller indicator field.

In SR11 systems with 7 or 8 controllers, 3 controllers are connected to two supply phases, and considering the load-carrying capacity of connections, the power of heaters in the mould should be matched so as the current of one supply phase does not exceed 32 A.

The simplified diagram of internal connections of the SR11-8XXXX is presented on the fig. 9 for common thermocouple and heater wires, and on the fig.10 for separate thermocouple and heater wires.

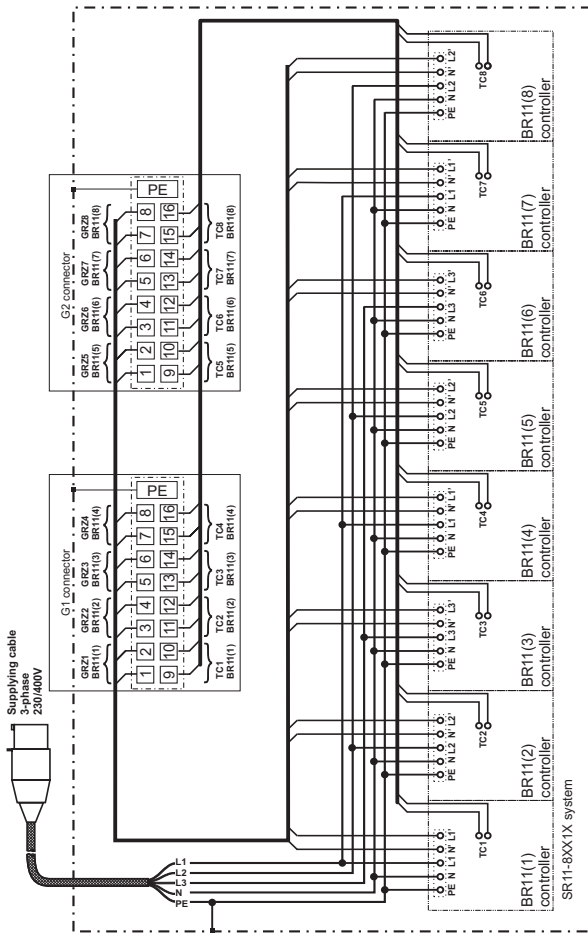

Fig. 9. Simplified diagram of internal SR11-8XX1X system connections.

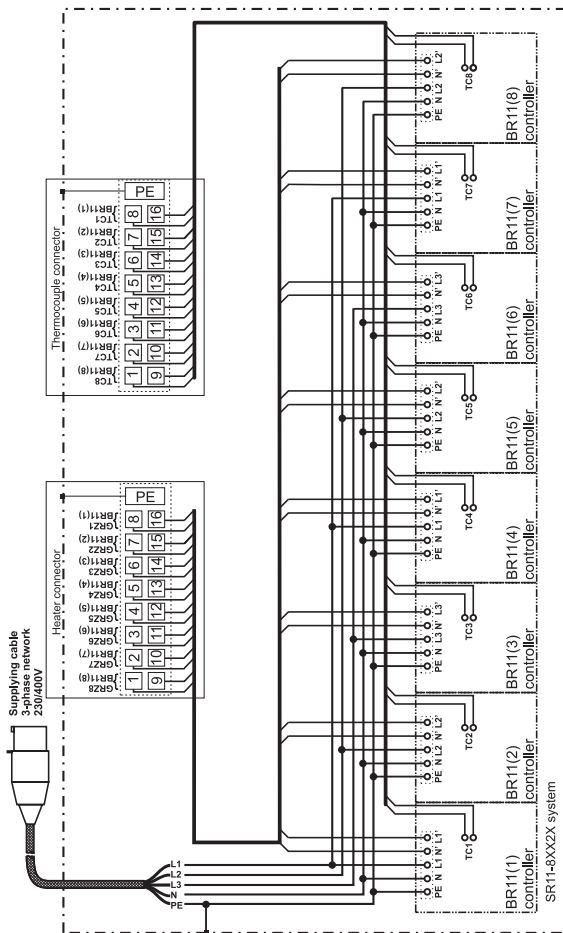
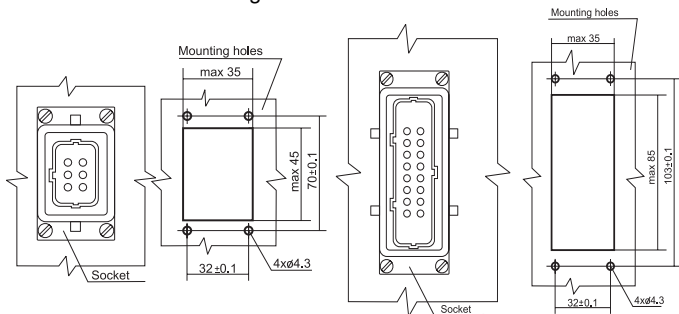

Fig.10. Simplified diagram of internal SR11-8XX2X system connections.

Moulds with heated channels are connected with the SR11 system by means of four types of cables. Cables are equipped in standard with 6-plug 380 V connectors for the SR11.11X1X system or with 16-plug 380 V connectors for other systems.

The view of mounting holes and the mounting way of sockets in moulds are shown on fig.11 and 12.



**Fig.11.** Mounting way of the plug-in socket on the injection mould for the SR11-11X1 system including 1 BR11 controller (on the left) or SR11-3XX1X including 2 or 3 BR11 controllers (on the right).

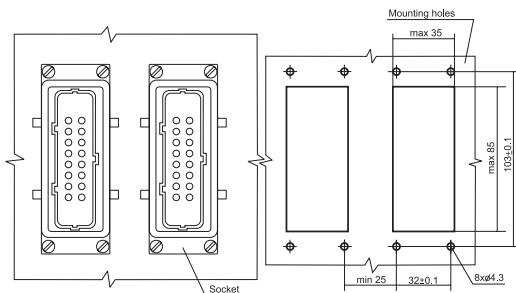

**Fig. 12.** Mounting way of the plug-in socket on the injection mould for the SR11-6XXXX system including 4, 5 or 6 BR11 controllers or for SR11-8XXXX including 7 or 8 BR11 controllers.

Connections of the SR11 system with the mould through the connecting cable should be made in compliance with the version of the possessed system, acc. to fig. 13 to 18. On figures below, contact numbers in connectors and occurring signals for them are presented. One should connect heaters and mould thermocouples so as the heater and thermocouples from one heating zone were connected to the pair of signals marked **GRZx** and **TCx**, assigned to the controller x.

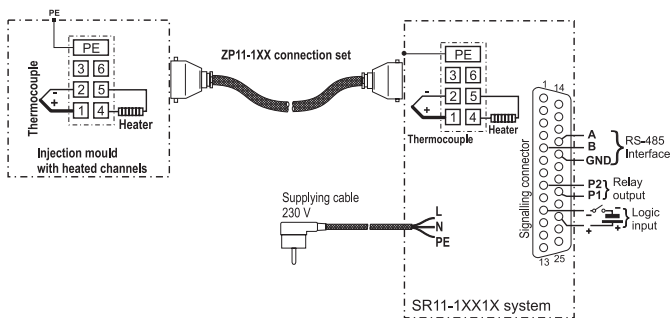

Fig. 13. Connection diagram of external SR11-1XX1X system connections.

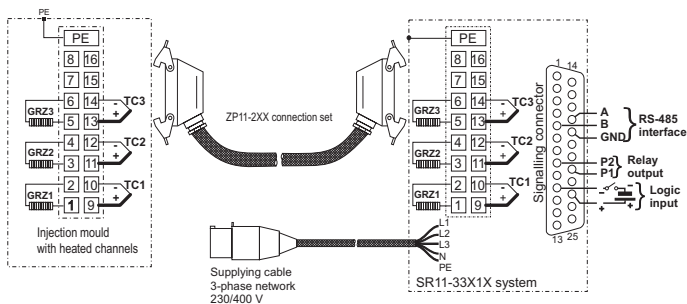
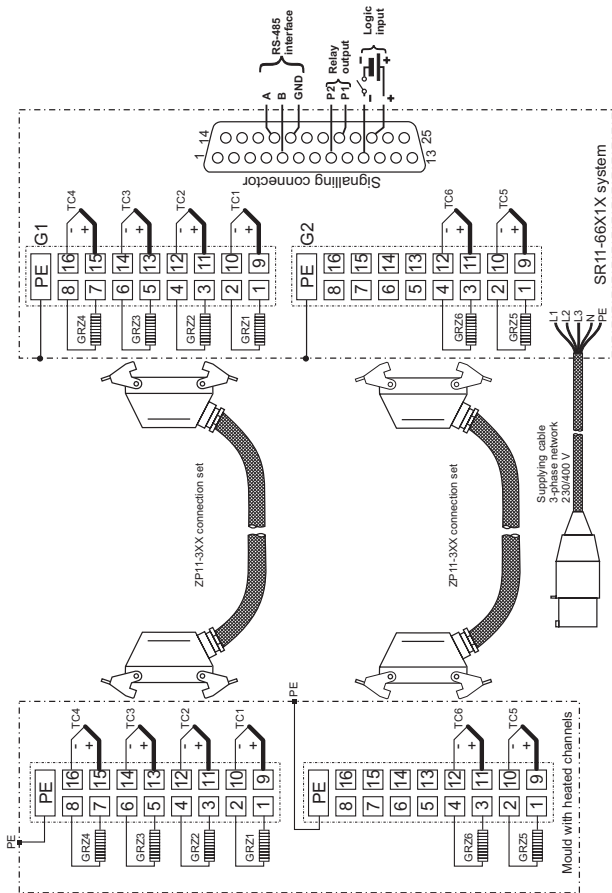

Fig. 14. Connection diagram of external SR11-33X1X system connections including 3 blocks of BR11 controllers.



**Fig. 15. Connection diagram of external SR11-66X1X system connections including 6 blocks of BR11 controllers.**

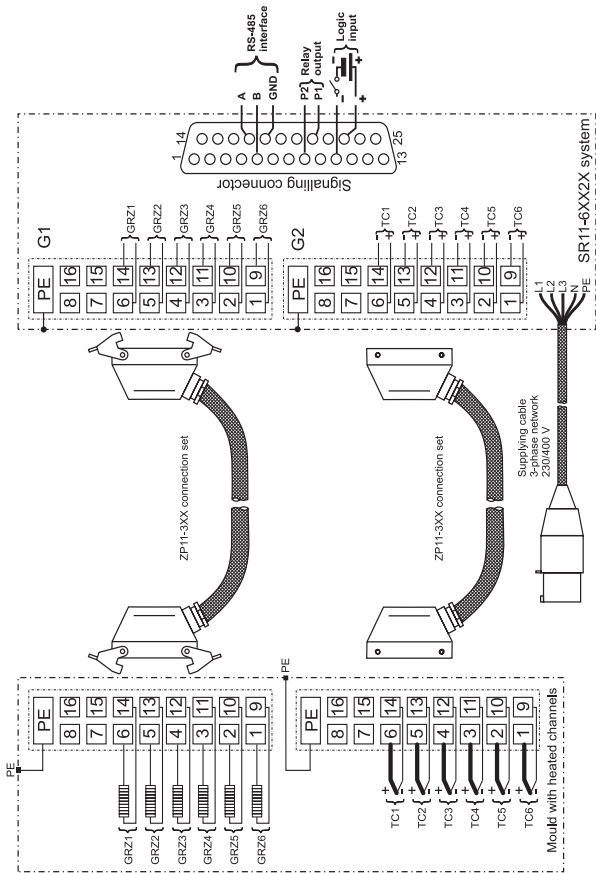

Fig. 16. Connection diagram of external SR11-66X2X system connections including up to 8 blocks of BR11 controllers.



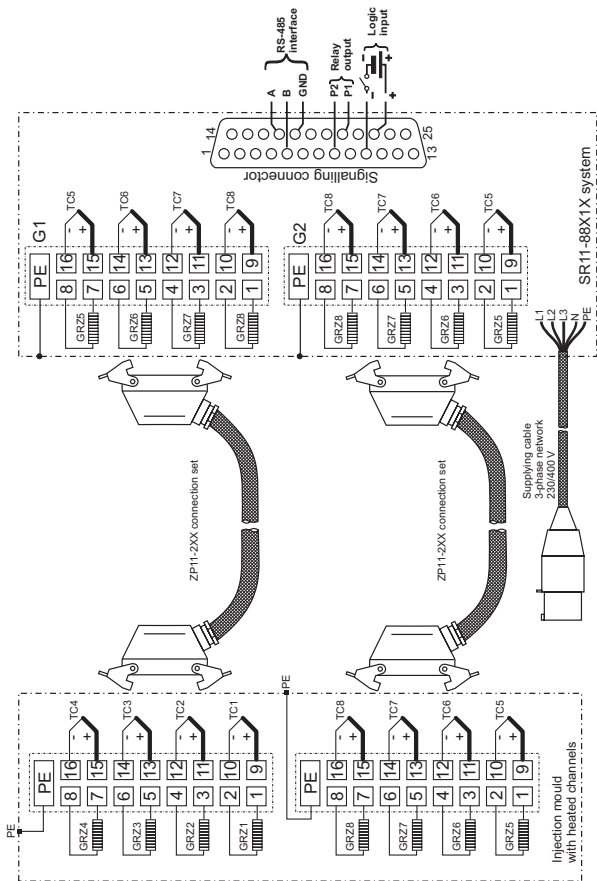

Fig. 17. Connection diagram of external SR11-88X1X system connections including 8 blocks of BR11 controllers.

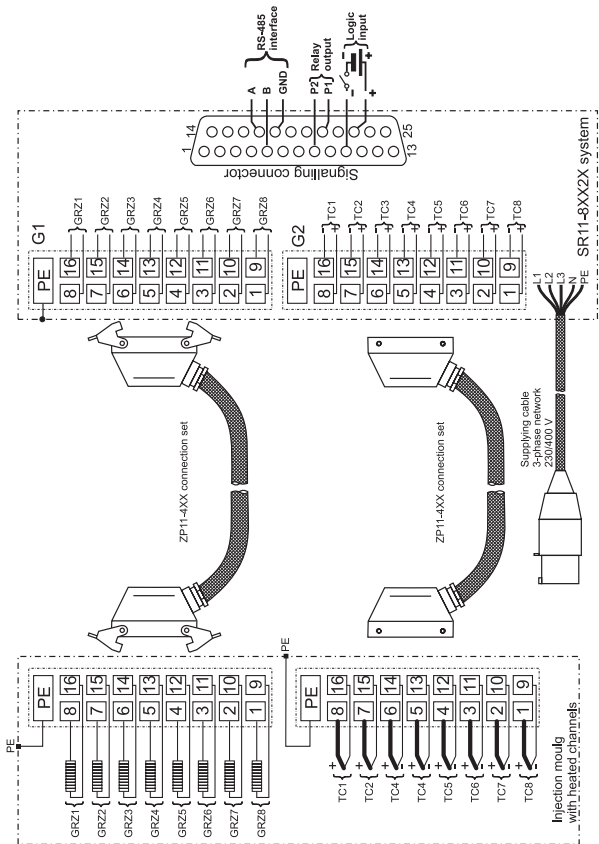
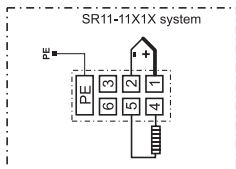
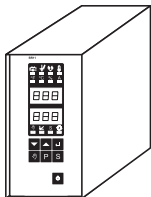

Fig. 18. Connection diagram of external SR11-88X2X system connections including 8 blocks of BR11 controllers.

In the table below, connectors of the SR11 system with used pins for versions with different numbers of controllers.

### SR11-11X1X



### SR11-32X1X

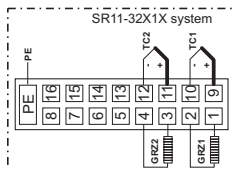
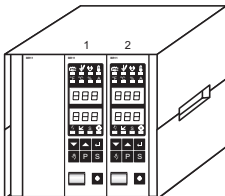

### SR11-33X1X

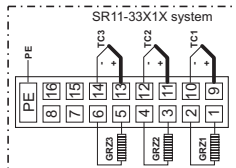
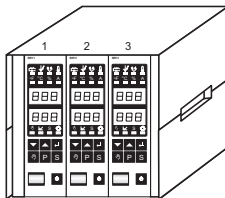

### SR11-64XXX

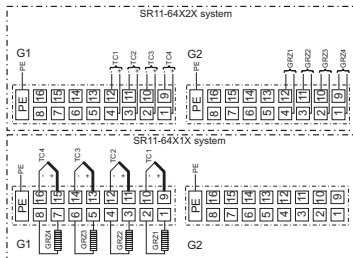
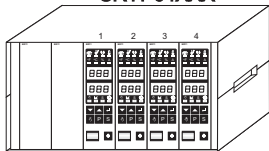

### SR11-65XXX

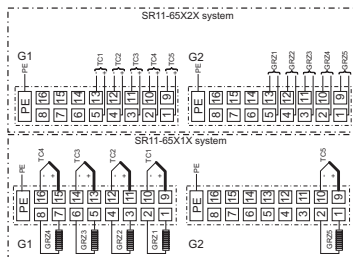
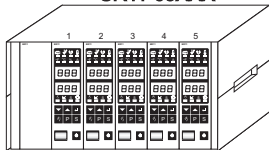

### SR11-66XXX

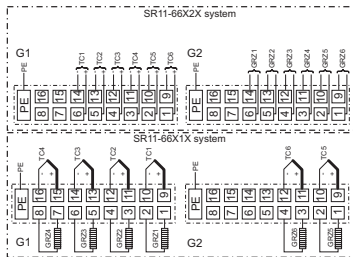
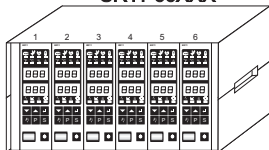

## SR11-87XXX

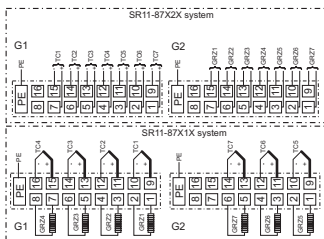
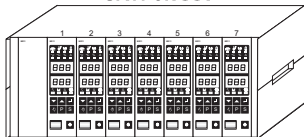

## SR11-88XXX

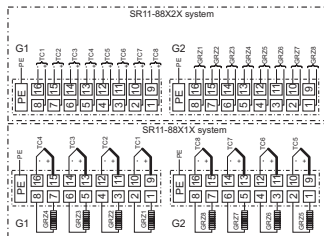
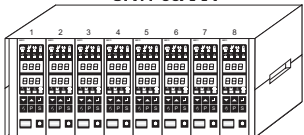

Before connecting the supply voltage, one must strictly carry out checking of the electrical connection conformity.

One must measure the resistance of all heating zones and the isolation resistance both between individual circuits and the PE wire.

After confirming the correctness in installation connections on the injection mould, one must connect connection cable plugs with appropriate sockets of multiple-contact connectors.

After turning the main supply on, successive heating zones are turned on by push-buttons situated on the controller frontal plate.

After turning controllers on, one must set the required temperature value in the way described in the user's manual of BR11 controllers.

In order to pull out the BR11 controller from the system housing, one must absolutely turn the main supply off, and next undo fixing nuts and take the controller out, catching it by the holder.

During the controller insertion into the system housing, one must pay attention that the controller plate edges were placed in the housing guides and next, one must insert the controller into the housing so that it becomes levelled with the other controllers, and screw it.

**It is forbidden to push and pull BR11 controllers when the main power switch is turned on!**

## 1.5. Way of Serial Interface Connection

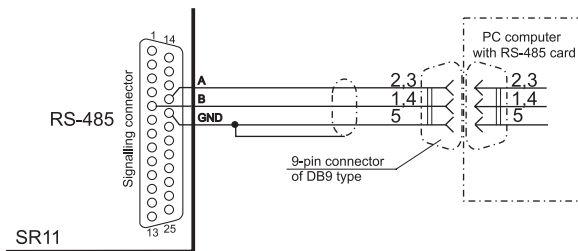

*Fig.19. Way of SR11 system connection to the PC computer.*

To obtain the connection with the PC computer of IBM class an interface card is indispensable, a RS-232/RS-485 converter (e.g. PD51) or USB/RS-485 converter (e.g. PD10).

The RS-485 standard allows to the direct connection of 32 devices (controllers) on a single serial link of 1200 m long. For the connection of a higher number of devices it is necessary to apply additional intermediate-to separating systems. One must carry out connections by shielded wires.

Each BR11 controller must have set the same transmission mode and speed and different addresses.

## 1.6. Technical Data of the System

<b>Input signal</b>	Thermoelement: Fe-CuNi (J)
<b>Control range and temperature measurement</b>	0...537°C; 32...999°F
<b>Basic measurement error</b>	≤ 0.2% of the range ±1 digit
<b>Admissible load</b>	15 A/heating zone, max current consumed from one supply phase: ≤ 32 A
<b>Measurement of the output current</b>	0...15 A with 0.1 A resolution
<b>Kind of power control:</b>	phase(during the soft start) impulse (during the control)
<b>Pulse repetition period</b>	automatically selected
<b>Impulse resolution</b>	1% of the max. power
<b>Kind of work:</b>	automatic control manual control
<b>Communication with the computer</b>	RS-485 interface
<b>Communication protocol</b>	MODBUS
<b>Baud rate</b>	2400, 4800, 9600, 19200 bits
<b>Transmission mode</b>	ASCII - 8N1, 7E1, 7O1 RTU - 8N2, 8E1, 8O1, 8N1
<b>Address</b>	0...247
<b>Maximal response time</b>	700 ms
<b>Rated service conditions:</b>	
- supply voltage of the 2...8 - zone system	3 x 230 V/400 V a.c. ± 10%; 50/60 Hz ± 10%
- supply voltage of the 1 - zone system	230 V a.c. ±10%; 50/60 Hz ±10%
- ambient temperature	0...40°C
- atmospheric pressure	86...106 kPa
- relative air humidity	< 85% without condensation

- pre-heating time 30 min.
- work position vertical

**Moc pobierana przez 1 regulator** < 7 VA

**Storage and handling conditions:**

- storage temperature -20...70°C

**Additional error in rated service conditions caused by the change of ambient temperature.**

≤100 % of the basic error value/10 K

**Housing protection**

**degree acc. to EN 60529** IP30

**Safety requirements acc. to EN 61010-1:**

- installation category III
- pollution degree 2
- maximal phase-to-earth work voltage:
  - for supply circuits 300 V
  - for output circuits 300 V
  - for other circuits 50 V

**Electromagnetic compatibility:**

- noise immunity acc. to EN 61000-6-2
- noise emissions acc. to EN 61000-6-4

Table 1. Overall dimensions of the SR11 system cassette

Cassette overall dimensions:	SR11-1XXXX	R11-3XXXX	SR11-6XXXX	SR11-8XXXX
height [mm]	200	197		
width [mm]	77,5	215	365	465
depth [mm]	355			
Weight of SR11 system [kg] ca.	2	7	10	12



## **2. USER'S MANUAL OF THE BR11 CONTROLLER**

---

### **2.1. Application**

BR11 controllers applied in SR11 systems are destined for a precise temperature control of injection moulds with heated channels.

The soft start function enables the mould pre-heating, and the PID control with autotuning and the Fuzzy Logic algorithm ensures the optimum control.

They can be applied for temperature control in various plastics processing systems.

Most important controller features:



- measurement input: thermocouple J,
- measuring range: 0...537°C (32...999 °F)
- signalling of breaks, short-circuits and inverse polarization of the sensor,
- measurement of the heater leakage current and detection of the maximal current exceeding,
- measurement of the load current, detection and damage signalling
- emergency work after the thermocouple damage, with a mean power which has been delivered before the damage or with the turned output off
- RS-485 interface, MODBUS protocol, ASCII and RTU modes
- logic input to the remote switching in the decreased temperature mode
- relay output to signal the control deviation exceeding.

## 2.2. Starting the Work

After turning the main supply on by means of the main switch, one can start individual controllers by pressing and holding down the  push-button during 2 seconds..

After starting, the controller carries out internal circuit tests, displays the program version and transits to the soft start phase, what signals the lighted  indicator. This stage lasts from 5 till 12 minutes. The measured temperature is displayed on the upper display, and the current intensity of heaters in amperes, on the lower display.

After the soft start, the controller performs the algorithym of the automatic selection of PID parameters. This phase is signalled by the impulse lighting of the  indicator.

After the object identifying, the controller calculates automatically parameter values of the PID algorithym and Fuzzy Logic, and transits to the automatic control. The automatic control is signalled by a constant lighting of the  indicator. The set point is displayed on the lower display. It can be changed by  and  push-buttons.

## 2.3. Servicing

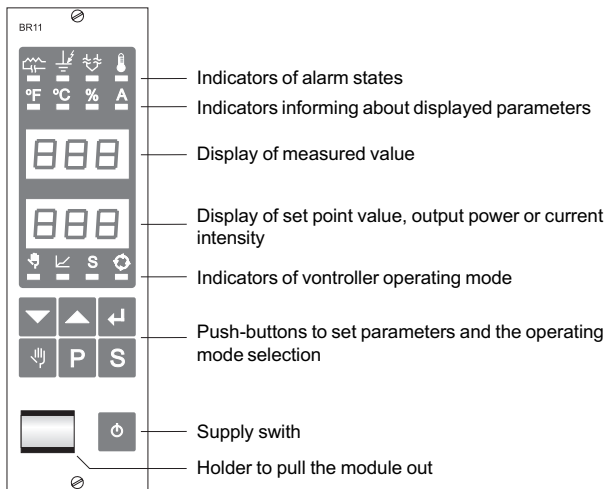

Fig.20. Frontal plate

### 2.3.1. Functions of Indicators

There are 12 indicators in 3 groups, on the frontal plate. The first group of indicators in red colour signals errors related to the controlled object.



damage in the load circuit



exceeding of the max. leakage current



damage in the circuit of the measuring sensor



relative lower or upper alarm from the deviation

The second group of indicators in green colour informs about displayed parameters.



temperature unit for the displayed value - °F



temperature unit for the displayed value - °C



output lower in % on the lower display



current flowing through the load on the lower display

The third group of indicators in green colour informs about the controller operating mode.



manual operating mode



„soft start” mode ; the flickering signals the autotuning phase









mode of decreased temperature, the flickering signals the turn of the mode on by the logic input.



automatic operating mode

## 2.3.2. Functions of Push-buttons

Table 2. Functions of push-buttons in operating modes



Mode Push-button	Soft start	Automatic control mode	Decreased temperature mode	Manual operation	Programming
	omission of soft start	increase of the SP set point	increase of the SPL value	increase of the power value on the output	transition to the previous parameter or increase of the parameter value
	—	decrease of the SP set point	decrease of the SPL value	decrease of the power value on the output	transition to the next parameter or decrease of the parameter value
	Switching of the successive parameter display on the lower display :			- output power - intensity of the load current	beginning of the parameter setting change or acceptance of the set value
	- set point - output power - intensity of the load current				
	entry in the programming mode				exit from the programming mode
	entry in the manual operating mode			exit from the manual operating mode	—
	—	switching the controller in the decreased temperature mode	switching the controller in the automatic operating mode	turning the output off	resignation of introduced changes
	controller on/off				

## 2.4. Operating Mode of the Controller

### 2.4.1. Soft start

In order to the correct temperature control of the injection mould it is necessary to dry moist heaters, what is realized in the soft start phase. In the drying phase, the delivered power to the heaters changes gradually from 5% of power to the value defined by the  $P5$  parameter, in order to reach the temperature defined by the  $SP_r$  parameter. The drying process of heaters lasts from 5 to 12 minutes.





### 2.4.2. Autotuning

If the  $RAA$  parameter is set on  $ON$ , then after the soft start, the controller maintains the  $SP_r$  temperature during ca 1 minute, and next matches automatically PID parameters. The phase is signalled by the impulse lighting of the  indicator. The pressure of  or  push-buttons during the identification duration causes the autotuning break without the calculation of PID parameters. After the identification, the controller calculates automatically  $P$ ,  $t_i$ ,  $t_d$  and transits to the automatic control.

### 2.4.3. Automatic Control

During the automatic control, the BR11 controller operates as a PID controller assisted by the algorithm of the Fuzzy Logic control (parameter  $FL$  set on  $ON$ ) maintaining the temperature in the mould with heated channels on  $SP$  level. PID parameters are automatically matched ( $RAA$  parameter set on  $ON$ ), one can also set them manually, if there is such a need. The automatic control is signalled by a constant lighting of the  diode.

During the automatic control, one can:

- change the set point by  and  push-buttons,
- change the parameter on the lower display by the  push-button,
- transit to the manual control by the  push-button,

- d) review and edit parameters by the **P** push-button,
- e) transit to the decreased temperature mode by the **S** push-button.

In case of alarm states, the automatic control is broken and an appropriate message appears on the lower display.



#### 2.4.4. Mode of Decreased Temperature



During the operation break of the mould with heated channels, it is useful to not admit moisture to heaters and maintain the mould to a fast and safe return to work. The mode to maintain the decreased temperature to the value set by the **SPt** parameter, serves for this aim. One can enter in two ways into this mode: through pressing the **S** push-button or remotely through turning the logic input on. In the second case, the *r in* parameter must be set on **on**. The remote switching by the logic input enables simultaneously the switching of modes in all zones. The decreased temperature mode is signalled by the **S** indicator.

In the decreased temperature mode it is possible to:



- a) transit to the automatic operating mode by the **S** push-button,
- b) a fast change of the **SPt** set point by and **▲** and **▼** push-button,
- c) the change of displayed parameters on the lower display by the **↵** push-button,
- d) transit to the manual operating mode by the **👉** push-button,
- e) transit to review and edition of parameters by the **P** push-button.



## 2.4.5. Manual Control

One can transit to the manual control from any operating mode by pressing the  push-button; this mode is signalled by the  indicator. The temperature is displayed on the upper display and the power value in %, on the lower display.

One can change the power value by means of  and  push-buttons. The set value is immediately transmitted to the control part.

The  push-button causes the immediate output turn off (the output power is being reset).

By means of the  push-button, one can set the display of the heater current on the lower display, till the moment of the next pressure of the  or  push-button.

It is possible to transit to the review and parameter edition in the manual mode by the  push-button, the control signal remains constant during this time. The end of the manual control follows after the renewed pressure of the  push-button.

## 2.4.6. Controller Operation at Voltage Supply Decay

In case of a voltage supply decay, the device state is stored. Owing this, after the supply recovery, the controller returns to the state before the voltage decay, or begins the soft start.

If the mould temperature is lower than the  $SP_r$  temperature, then the control transits to the soft start, otherwise it transits to the automatic mode or decreased temperature mode.

If the controller was turned on during the manual operating mode, then the controller returns to the mode with the output signal value, which was set before the voltage decay.



## 2.5. Review and Change of Parameters

The review and parameter change can be carried out in any controller operating mode after pressing the **P** push-button. The name of the first parameter appears on the upper display, and its value on the lower display. By means of **▲** and **▼** push-buttons, one can transit to the display of the next or previous parameter, in the sequence according to the table 3.

To measure the parameter value, one must:

- press the **↵** push-button; the parameter value is flickering,
- pressing **▲** and **▼** push-buttons, set the required parameter value,
- press the **↵** push-button again, what means the acceptance of the new parameter value, or the **S** push-button, to resign from the change.

If during 45 sec., none of the push-buttons is not been pressed, the controller come out from the programming mode.

A renewed pressure of the **P** push-button ends the review process and causes the transit to the previous state.





Table 3. List of parameters

	Parameter	Range	Factory setting	Parameter description
1	<i>SP</i>	0...537 °C 32...999 °F	200 °C	Set point
2	<i>SP<sub>L</sub></i>	37...149 °C 100...300 °F	120 °C	Set point for the decreased temperature mode
3	<i>SP<sub>r</sub></i>	90...160 °C 194...320 °F	90 °C	Set point for the soft start
4	<i>PS</i>	5...100 %	50	Maximal admissible power delivered to the heater during the soft start
5	<i>R<sub>dh</sub></i>	2...20 °C 36...68 °F	10 °C	Difference between the set value and the temperature above which, one must signal the alarm
6	<i>R<sub>dl</sub></i>	2...20 °C 36...68 °F	10 °C	Difference between the set value and the temperature below which one must signal the alarm
7	<i>P</i>	1...999 %	4	Proportional band in % of the measuring range
8	<i>t<sub>i</sub></i>	0...999 sek.	120	Integration time-constant
9	<i>t<sub>d</sub></i>	0...999 sek.	20	Differentiation time-constant
10	<i>SEL</i>	0..999	0	Safety code
11	<i>R<sub>dr</sub></i>	0...247	0	Controller address in the network
12	<i>uEg</i>	°C, °F	°C	Temperature unit: °C - °Celsius °F - °Fahrenheit
13	<i>Aut</i>	on, off	on	Autotuning algorithm turned On/Off after the soft start on - turned on off - turned off

14	<i>FL</i>	<i>on,off</i>	<i>off</i>	Fuzzy Logic autotuning algorithm turned on/off during the automatic control: <i>on</i> - turned on <i>off</i> - turned off
15	<i>Rud</i>	<i>on,off</i>	<i>off</i>	Alarm output turned on/off, when the alarm from the temperature is active <i>on</i> - turned on <i>off</i> - turned off
16	<i>rin</i>	<i>on,off</i>	<i>off</i>	<i>on</i> - active logic input (shorted) switches in the decreased temperature mode <i>off</i> - input is inactive
17	<i>tc b</i>	<i>on,off</i>	<i>off</i>	Output state during the alarm from the measuring input: <i>on</i> - output set on the signal from the manual operation or on the mean power preceding the damage <i>off</i> - output turned off
18	<i>bus</i>	<i>off</i> <i>Rn i</i> <i>RE i</i> <i>Ro i</i> <i>rn2</i> <i>re i</i> <i>ro i</i>	<i>off</i>	Data format during the communication with the master system <i>off</i> - communication turned off <i>Rn i</i> - ASCII mode, 8 data bits, without the parity bit, 1 stop bit <i>RE i</i> - ASCII mode, 7 data bits with the parity bit, 1 stop bit <i>Ro i</i> - ASCII mode, 7 data bits with the odd parity bit, 1 stop bit <i>rn2</i> - RTU mode, 8 data bits, without the parity bit, 1 stop bit <i>re i</i> - RTU mode, 8 data bits, with the parity bit, 1 stop bit <i>ro i</i> - RTU mode, 8 data bits, with the odd parity bit, 1 stop bit <i>rn i</i> - RTU mode, 8 data bits, without the parity bit, 1 stop bit.



19	<i>bud</i>	2.4 48 96 192	96	Baud rate: 2.4 - 2400 bits/sec. 48 - 4800 bits/sec. 96 - 9600 bits/sec. 192 - 19200 bits/sec.
----	------------	------------------------	----	---

## Safety code

The safety code serves to secure against the change of introduced data by non-authorized persons. The factory code is set on 000, what means that parameters can be modified without the necessity of the previous introduction of the correct safety code. If the safety code is different from zero, then at the first pressure of the  push-button after the entry into the programming mode, the **SEC** parameter name appears on the upper display, and the flickering 000 value on the lower display. By means of  and  push-buttons, one must give the appropriate code and press the  push-button.

In case of an erroneous code, the **ERR** message appears. After pressing whichever push-button, the message disappears and the controller return to the review option of parameters.

In order to change the safety code, one must first, give its current value and then, when the **SEC** inscription appears, introduce the new value.





In order to reset the safety code to zero, one must display the **SEC** parameter, and next, press simultaneously  and  push-buttons.

## 2.6. ALARM STATES

### 2.6.1. Alarms Signalled During the Work

The BR11 controller detects alarm states and informs about them by a message and lighting the appropriate indicator. Alarm descriptions, their reasons and the controller operation are presented on the table 4.

Table 4. Alarm states

Alarm reason	Message	Indicator is lighting	Power output signal in %	
			During the soft start	During the automatic operation
Sensor short-circuited	$\mathcal{E}, S$		15 %, phase control	0 %, when $\mathcal{E} \mathcal{L} b = o f f$ mean power before the damage, when $\mathcal{E} \mathcal{L} b = o n$
Sensor opened	$\mathcal{E}, o$			
Inverse polarisation of the sensor	$\mathcal{E}, r$			
Exceeding of the maximal heater current	$\mathcal{E} h H$		0 %	0 %
SSR short-circuited	$\mathcal{E} S c$		15 %, phase control	Power calculated from the control algorithm
Heater circuit opened	$\mathcal{E} h o$		25 %, phase control	
Damage of the fuse*	$\mathcal{E} F u$			
Exceeding of the maximal heater leakage current value	$\mathcal{E} L H$		15 %, phase control	
Exceeding of the admissible upper deviation	lack		The control is continued; the alarm output is turned on acc. to the $R_{u d}$ parameter	
Exceeding of the admissible lower deviation				

\* See also section 2.6.3

Messages about alarms in the load circuit are displayed on the upper display alternately with the temperature.

## 2.6.2. Errors Detected After Turning the Supply on

After turning the supply on, the controller carries out internal tests of circuits. In case of any abnormality statement, the *ERR* message and error number will be displayed (see table 5).

Table 5. Coding way of errors and their meaning

Error No	Meaning
001	Incorrect value of the reference voltage. Measurements of temperature and current can be inaccurate
002	Incorrectly operating detector detecting transition of the supply voltage through zero. After detecting this error, further tests are not continued, except tests of EEPROM memory. Both current measurements and control of delivered power to the load, can be inaccurate.
004	Incorrect operating circuit of the heater current measurement. Current measurements can be inaccurate.
016	Shorted sensor of contact temperature measurement. When measuring the temperature, the temperature of contacts is not taken into account.
032	Opened sensor of contact temperature measurement. When measuring the temperature, the temperature of contacts is not taken into account.
064	Incorrect checksum of the EEPROM memory. Measurements of temperature and current can be inaccurate.
128	Incorrect parameters in the EEPROM memory. Measurements of temperature and current can be inaccurate.

If the displayed value is different than in the table 5, one must decompose the displayed error number into the sum of numbers from the table 5.

*Example:*

The number 097 has been displayed. We decompose 97 into the sum of numbers from the table 5:

$$97 - \underline{64} = 33; \quad 33 - \underline{32} = 1; \quad (64 + 32 + 1 = 97)$$

So, the message 97 means, that errors numbered by 001, 032, 064 have been detected.

### **2.6.3. Replacing the Fuse in the Controller**

Before approaching to the fuse replacement, one must be sure that the main switch is set on the OFF position, next take the controller module out from the cassette and replace the fuse by a fuse of the same type. Before the imbedding of the controller into the cassette, one must check if there is not other accidental things in the cassette. Next, one must insert the controller into the cassette so that edges of the printed circuit will be in the upper and lower cassette guides. One must put the controller into the cassette as far as we feel a resistance and tighten, so that the frontal edge of the controller comes up with the cassette edge.

## 2.7. Communication with the Master System

### 2.7.1. Introduction

BR11 controllers are optionally equipped with serial links in RS-485 standard for the communication in computer systems and with other devices fulfilling the master function.

The asynchronous character MODBUS communication protocol has been implemented on the serial link.

BR11 controllers in the SR11 system must have set different addresses, but the same modes and baud rates.

Set of serial link parameters of BR11 controllers:

- controller address - 1..247
- baud rate - 2400, 4800, 9600, 19200 bits/sec,
- operating modes - ASCII, RTU,
- information unit - ASCII: 8N1, 7E1, 7O1;  
- RTU: 8N2, 8E1, 8O1, 8N1
- maximal response time - 700 ms

### 2.7.2. Function Description

Following MODBUS protocol functions has been implemented in the BR11 controller:

Function	Meaning
03 (03h)	Readout of n-registers
06 (06h)	Write of a single register
16 (10h)	Write of n-registers
17 (11h)	Identification of the slave device



## Readout of n-registers (function 03)

The function enables the readout of values included in 16-bit registers in the addressed slave device.

The request frame defines the 16-bit beginning register address and the number of registers to readout. The maximal number of registers to readout by one command is equal 24 in the BR11 controller. The function is not accessible in the broadcasting mode.

Example: Readout of 3 registers in RTU mode beginning from the register addressed 4000 (0FA0h).

Request:

Device address	Function	Register address		Number of registers		Checksum CRC
		Hi	Lo	Hi	Lo	
02	03	0F	A0	00	03	06CE

Answer:

Device address	Function	Number of bytes	Value in the register 4000		Value in the register 4001		Value in the register 4002		Checksum CRC
			Hi	Lo	Hi	Lo	Hi	Lo	
02	03	06	00	C9	00	64	00	5A	2871

## Writing the Value to the Register (function 06)

This function enables the modification of the register contents. The function is accessible in the transmission mode.

Example. Request of the value 205 (0CD hex) write into the register 4000 (0FA0 hex).

Request:

Device address	Function	Register address		Register value		Checksum CRC
		Hi	Lo	Hi	Lo	
02	06	0F	A0	00	CD	485A

Answer:

The correct answer to the value write request into the register is the message retransmission after carrying the operation out.

## Write to n-registers (function 16)

The function enables the modification of register contents. The maximal number of registers to write by one command is equal 17 in Br11 controllers.

The function is accessible in the broadcast mode.

Example: write of two registers beginning from the register addressed 4000.

Request:

Device address	Function	Address of the initial register		Number of registers		Number of bytes	Value of the register 1		Value of the register 2		Checksum CRC
		Hi	Lo	Hi	Lo		Hi	Lo	Hi	Lo	
02	10	0F	A0	00	02	04	00	C8	00	6E	B771

Answer:

The correct answer includes the slave unit address, function code, initial address and the number of written registers.

Device address	Function	Register address		Number of registers		Checksum CRC
		Hi	Lo	Hi	Lo	
02	10	0F	0A	00	CD	42CD

### Report Identifying the Device (code 17)

The function enables the user to obtain information about the device type.

The function is not accessible in the transmission mode.

Example

Request:

Address	Function	Checksum CRC
02	11	C0DC

Answer:

Address	Function	Number of bytes	Device identifier	Checksum CRC
02	11	01	8E	D06D

The „Device identifier „ field in the answer frame means, the unique identifier of the given device class.

### 2.7.3. Codes of Transmission Errors

When the master device sends the request to the slave device then, except messages in broadcasting mode, it expects a correct answer. After sending the master unit request, one of the four possible events can appear:

- If the slave unit receives the request without a transmission error and can perform it correctly, then returns the correct answer.
- If the slave unit does not receive requests, none request is returned. In the master device program, timeout conditions for requests will be fulfilled.
- If the slave unit receives the request, but with transmission errors (parity error, of checksum LRC or CRC), none answer is returned. *Timeout* conditions for requests will be fulfilled in the master device program.
- If the slave unit receives the request without transmission errors, but cannot perform it correctly (e.g. if the request is a non-existing readout of the bit output or register), then it returns the answer including the error code, informing the master device about the error reason.

The message with the erroneous answer includes two fields differentiating it from the correct answer:

**Field of the function code:** In the correct answer, the slave unit retransmits the function codes from the request message in the code field of the answer function.

All function codes have the most significant bit (MSB) equal 0 (codes values are below 80 h).

In the erroneous answer, the slave device sets the function code MSB bit on 1. It causes that the function code value in the erroneous answer is exactly by 80h higher than it would be in the correct answer.

On the base of the function code with the set MSB bit, the master device program can recognise the erroneous answer and can check the error code on the data field.

**Data field:** In the correct answer, the slave device can return data on the data field (certain information requested by the master unit).

In answer, the slave device returns the error code on the data field. It defines conditions of the slave device, which caused the error. In the table below, possible error codes and their meanings are presented:

Error code	Meaning
01	Forbidden function
02	Forbidden data address
03	Forbidden data value

## 2.7.4. List of Registers

Data are placed in 16-bit registers in the BR11 controller.

Table 6. Registers of MODBUS protocol

Register address	Parameter name	Register meaning	Register Type <sup>1)</sup> R-Readout W-Write	Range of values	Notes
4000	$SP$	Set point	R,W	0...537 32...999	°C °F
4001	$SP_L$	Set point for the decreased temperature mode	R,W	37...149 100..300	°C °F
4002	$SP_r$	Set point for the soft-start	R,W	90...160 194..320	°C °F
4003	$P5$	The highest delivered power to the heater during the soft start	R,W	5...100	%

4004	<i>Rdh</i>	Relative upper alarm from the deviation	R,W	2...20 36...68	°C °F
4005	<i>Rdl</i>	Relative lower alarm from the deviation	R,W	2...20 36...68	°C °F
4006	<i>P</i>	Proportional band	R,W	1...999	in % of the measuring range
4007	<i>t<sub>i</sub></i>	Integration time-constant	R,W	0...999	sec
4008	<i>t<sub>d</sub></i>	Differentiation time-constant	R,W	0...999	sec
4009	<i>SEC</i>	Safety code	R,W	0...999	
4010	<i>dEG</i>	Temperature units <sup>2)</sup>	R,W	0,1	0 - °C 1 - °F
4011	<i>RUR</i>	Tuning of PID algorithm	R,W	0,1	0 - off 1 - on
4012	<i>FL</i>	Fuzzy Logic algorithm	R,W	0,1	0 - off 1 - on
4013	<i>Rud</i>	Alarm output state	R,W	0,1	0 - off 1 - on
4014	<i>rin</i>	Logic input state	R,W	0,1	0 - off 1 - on
4015	<i>tEb</i>	Way of emergency control	R,W	0,1	0 - turn the output off 1 - set the mean power
4016		Switching of modes <sup>3)</sup>	R,W	0,1	0 - decreased temperature mode 1 - automatic mode
4018		State of alarms	R		bit 0 - sensor short-circuited bit 1 - sensor opened bit 2 - inverse polarisation of the sensor

					bit 3 - upper alarm bit 4 - lower alarm bit 5 - load short-circuited bit 6 - load opened bit 7 - exceeding of the heater leakage current bit 8 - fuse burnout bit 9 - SSR short-circuited bity 10..15 - not defined
4019		Status word	R		bit 0 : 1- automatic mode; 0 - decreased temperature mode, bit 1 : 1- manual control ; 0 - automatic control, bit 2 : 1- active function of the PID parameter selection bit 3: 1- active fuzzy logic function bit 4: 1- active soft start bit 5: 1- phase control bit 6: 1- active logic input bit 7: 1- shot-circuited relay output bit 8 : 0 - °C, 1 - °F bits 9...15 - not defined

4020		Current temperature in the zone*10	R		In units set by the $\alpha E9$ parameter
4021		Current set point *10	R		In units set by the $\alpha E9$ Depending on the operating mode it is: SP, SPL or SPr
4022		Output power*10	R	0...1000	%
4023		Load current intensity *10	R	0...15	amperes
4024		Heater leakage current*10	R	0...250	miliamperes

<sup>1)</sup> R - for readout, W - for write

<sup>2)</sup> The command to change temperature units will not be performed if in the same time the parameter depending on units is changed from the keyboard, e.g. the set point.

<sup>3)</sup> If the controller is on the manual operating mode or soft start mode, then the interface function is not realised.

## 2.8. TECHNICAL DATA OF THE CONTROLLER

<b>Input signal</b>	Fe-CuNi thermocouple (J)
<b>Measuring range</b>	0...537 °C (0...999 °F)
<b>Compensation way of cold ends</b>	automatic
<b>Basic temperature measurement error</b>	0.2 % of the measuring range $\pm 1$ digit
<b>Logic input</b>	Voltage, 24 V
<b>Output signal</b>	0...15 A
<b>Kind of power control:</b>	
- phase (during the soft start)	
- impulse (during the control)	



<b>Impulse period</b>	selected automatically
<b>Measurement of the output current</b>	0...15.0 A
<b>Measurement of leakage current</b>	0...25.0 mA
<b>Dynamics</b>	PID + fuzzy logic control
<b>Proportional band</b>	1...999 % of the measuring range
<b>Integration time-constant</b>	0...999 s.
<b>Differentiation time-constant</b>	0...999 s.
<b>Soft start</b>	gradual temperature accretion to the $SP_r$ set value
<b>Autotuning</b>	after the soft start (when $RA_R$ is turned on)
<b>Supply decays</b>	return to the mode before decay

#### **Detection and damage signaling:**

- exceeding of the admissible value of the heater leakage current >22 mA
- damage of the load circuit,
- short-circuiting, break or inverse polarization in the circuit of the measuring sensor

#### **Alarm signalling from the deviation**

diode indicator and relay output

#### **Digital interface**

RS-485

- communication protocol

Modbus

- baud rate

2400, 4800, 9600, 19200 bit/s

- mode

ASCII - 8N1, 7E1, 7O1

RTU - 8N2, 8E1, 8O1, 8N1

- address

0...247

- maximal response time

700 ms

#### **Masking frame**

foil

#### **Number of buttons**

7

#### **Button to switch the supply off**

yes

<b>Displays</b>	2 x 3 digits
<b>Number of LED diodes</b>	12
<b>Rated operating conditions:</b>	
- supply voltage	230 V a.c. $\pm 10\%$
- supply voltage frequency	50/60 Hz $\pm 10\%$
- ambient temperature	0... <u>23</u> ...40°C
- storage temperature	-20...70°C
- relative air humidity	<85 % (without condensation)
- external magnetic field	<400 A/m
- pre-heating time	30 min
- work position	vertical
<b>Power consumption</b>	<7 VA
<b>Additional error in rated operating conditions caused by ambient temperature change</b>	
	$\leq 100\%$ of basic error value/10 K
<b>Controller dimensions</b>	50.6 x 174 x 175
<b>Controller weight</b>	0.65 kg
<b>Safety requirements acc. to EN 61010-1:</b>	
- installation category	III
- pollution degree	2
- maximal phase-to-earth working voltage:	
- for supply circuits:	300 V
- for output circuits	300 V
- for other circuits	50 V
<b>Electromagnetic compatibility:</b>	
- noise immunity acc. to EN 61000-6-2	
- noise emissions acc. to EN 61000-6-4	

### 3. ORDER CODES OF THE SR11 SYSTEM

When ordering the SR11 system one should define the code of the system version acc. to the table 7 and the code of the connection set acc. to the table 8. Optionally, one can order sockets for moulds acc. to the table 9.

Table 7. Version codes of the SR11 system

System for injection moduls with heated channels SR11-	X	X	X	X	X
<b>Housing dimensions:</b>					
housing width: 77,5 mm					
number of controllers: 1 .....	1				
housing width: 215 mm					
number of controllers: 2, 3 .....	3				
housing width: 365 mm					
number of controllers: 4, 5, 6 .....	6				
housing width: 465 mm					
number of controllers: 7, 8 .....	8				
<b>Number of controllers:</b>					
1 controller .....	1				
2 controllers .....	2				
3 controllers .....	3				
4 controllers .....	4				
5 controllers .....	5				
6 controllers .....	6				
7 controllers .....	7				
8 controllers .....	8				
<b>Interface RS-485:</b>					
without interface .....	0				
with interface .....	1				
<b>Connectors for the mould:</b>					
common connectors for thermocouples and heaters .....	1				
separate connectors for thermocouples and heaters <sup>1)</sup> .....	2				
<b>Extra requirements:<sup>2)</sup></b>					
without extra requirements .....	0				
with an extra quality inspection certificate .....	1				
acc. to user's agreements .....	X				

<sup>1)</sup> Concerns only the version with the housing width: 365 mm or 465 mm

<sup>2)</sup> After agreement with the manufacturer

**Order example:**

The code: **SR11- 3-2-0-1-0** means: SR11 - System for injection moulds with heated channels; 3 - Housing width = 215 mm; 2 - with 2 BR11 controllers; 0 - without RS-485 interface; 1 - with common connectors for thermocouples and heaters; 0 - without extra requirements

Table 8. Order codes for the ZP11 connection set

Connection set ZP11-	X	X	X
<b>System version:</b>			
SR11 with 1 controller			
One common cable for thermocouples and heaters ..... 1			
SR11 with 2, 3, 4, 5, 6, 7 or 8 controllers			
One common cable for thermocouples and heaters <sup>1)</sup> ... 2			
SR11 with 4, 5 or 6 controllers			
One cable for thermocouples ..... 3			
SR11 with 4, 5 or 6 controllers			
One cable for heaters ..... 4			
SR11 with 7 or 8 controllers			
One cable for thermocouples ..... 5			
SR11 with 7 or 8 controllers			
One cable for heaters ..... 6			
<b>Cable length:</b>			
3 m ..... 1			
6 m ..... 2			
<b>Extra requirements:</b>			
without extra requirements - standard version ..... 0			
with an extra quality inspection certificate ..... 1			
acc. to user's agreements <sup>2)</sup> ..... X			

<sup>1)</sup> For SR11 systems with 5, 6, 7 or 8 BR11 controllers, 2 cables are indispensable

<sup>2)</sup> After agreement with the manufacturer

**Order example:**

The code: **ZP11-1-2-0** means: ZP11 - Connection set for the SR11 system; 1 - for SR11 system with 1 controller and one common cable for thermocouples and heaters; 2 - with a 6 m long connection cable; 0 - without extra requirements

Table 9. Order codes of the GP11 socket set for moulds

Set of sockets for the mould <b>GP11</b>	<b>X</b>
<b>Kind of socket:</b>	
One male socket for the mould for the ZP11-1XX connection set .....	<b>1</b>
One male socket for the mould for the ZP11-2XX <sup>1)</sup> , ZP11-4XX or ZP11-6XX <sup>2)</sup> connection set .....	<b>2</b>
One female socket for the mould for the ZP11-3XX or ZP11-5XX <sup>3)</sup> connection set ....	<b>3</b>

<sup>1)</sup> For cables with common wires of heaters and thermocouples, one male socket is necessary for one cable.

<sup>2)</sup> For cables with separated wires of heaters and thermocouples, one male socket is necessary for one heater cable.

<sup>3)</sup> For cables with separated wires of heaters and thermocouples, one female socket is necessary for one thermocouple cable.

**Order example:**

The code: **GP11- 3** means: GP11 - Set of sockets for the mould  
 3 - With one female socket to the mould for the connection set ZP11-3XX and ZP11-5XX, for cables with separate heater and thermocouple wires.

## 4. MAINTENANCE AND WARRANTY

The SR11 system does not require a special periodical maintenance. In case of some incorrect operations:

1. After the dispatch date and within the period stated in the warranty card One should return the SR11 system to the Quality Inspection Dept. If the device has been used in compliance with the instructions, we warrant to repair it free of charge.

The disassembling of the housing causes the cancellation of the granted warranty.

2. After the warranty period:

One should send the device to repair it in an authorized service workshop.

Spare parts are available for the period of five years from the date of purchase.

Our policy is one of continuous improvement and we reserve the right to make changes in design and specifications of any products as engineering advances or necessity requires and revise the above specifications without notice.





Lubuskie Zakłady Aparatów Elektrycznych - LUMEL S.A.  
ul. Sulechowska 1, 65-022 Zielona Góra, Poland

Tel.: (48-68) 32 95 100 (exchange)

Fax: (48-68) 32 95 101

[www.lumel.com.pl](http://www.lumel.com.pl)

e-mail: [lumel@lumel.com.pl](mailto:lumel@lumel.com.pl)

Export Department:

Tel.: (48-68) 329 53 02 or 53 04

Fax: (48-68) 325 40 91

e-mail: [export@lumel.com.pl](mailto:export@lumel.com.pl)